

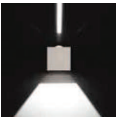

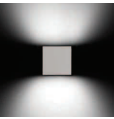







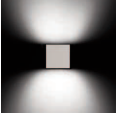



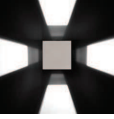

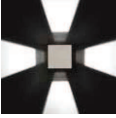
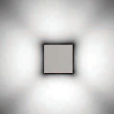

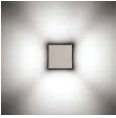





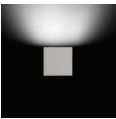

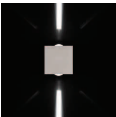
WALL LIGHTING - EXTERIOR



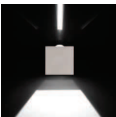

	Page SCUBA DE TWO WAY286		News Page BEAM 3 ONE WAY290		News Page LEO 80 - 35°295
	News Page BEAM 1 ONE WAY IP65 - 40°286		News Page BEAM 3 TWO WAY290		News Page LEO 80 - 4° / 4°295
	News Page BEAM 1 ONE WAY IP65 - 100°286		News Page BEAM 4 ONE WAY291		News Page LEO 80 - 4° / 35°295
	News Page BEAM 1 TWO WAY IP65 - 40°/100°287		News Page BEAM 4 TWO WAY291		News Page LEO 80 - 35° / 35°296
	News Page BEAM 1 TWO WAY IP65 - 100°/100°287		News Page BEAM 5 ONE WAY292		News Page LEO 80 - 4° / 4°296
	News Page BEAM 1 TWO WAY IP65 - 40°/40°287		News Page BEAM 5 TWO WAY292		News Page LEO 80 - 35° / 35°296
	News Page BEAM 2 ONE WAY IP65 - 40°288		News Page BEAM 6 ONE WAY293		News Page LEO 120 - 4°297
	News Page BEAM 2 ONE WAY IP65 - 100°288		News Page BEAM 6 TWO WAY293		News Page LEO 120 - 35°297
	News Page BEAM 2 TWO WAY IP65 - 40°/100°289		News Page BEAM 7 ONE WAY294		News Page LEO 120 - 75°297
	News Page BEAM 2 TWO WAY IP65 - 100°/100°289		News Page BEAM 7 TWO WAY294		News Page LEO 120 - 4° / 4°298
	News Page BEAM 2 TWO WAY IP65 - 40°/40°289		News Page LEO 80 - 4°295		News Page LEO 120 - 35° / 35°298

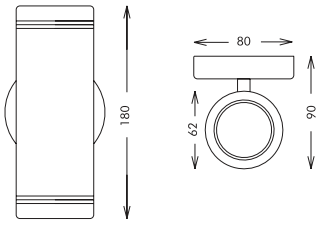

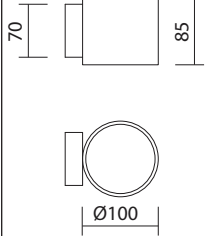
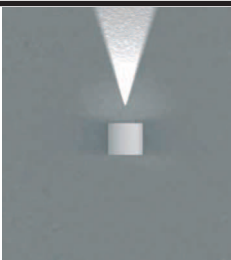

WALL LIGHTING - EXTERIOR

	News LEO 120 - 4° / 75°298	Page		News LEO 160 - 75° / 75°301	Page		TYCO305	Page
	News LEO 120 - 75° / 75°298-299	Page		News LEO 160 - 4°302	Page		TYCO305	Page
	News LEO 120 - 4°299	Page		News LEO 160 - 35°302	Page		+ Accessories News SLIM 3 - LED306	Page
	News LEO 120 - 35°299	Page		News LEO 160 - 75°302	Page		+ Accessories TUBE307	Page
	News LEO 120 - 75°299-300	Page		SCUBA SPOT303	Page		+ Accessories SLIM 5308	Page
	News LEO 160 - 4°300	Page		News FOCUS - LED303	Page			
	News LEO 160 - 35°300	Page		News FOCUS - LED with anti-glare louvre303	Page			
	News LEO 160 - 75°300	Page		News FOCUS Mini - LED303	Page			
	News LEO 160 - 4° / 4°301	Page		INTRA C304	Page			
	News LEO 160 - 35° / 35°301	Page		INTRA GA [open blind]304	Page			
	News LEO 160 - 4° / 75°301	Page		INTRA GA [closed blind]304	Page			

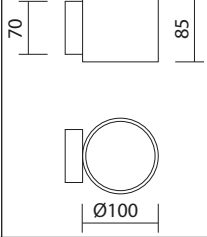
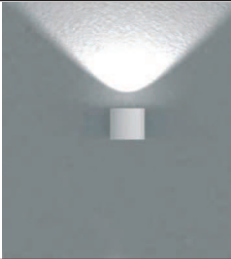

		 PAR 16 <ul style="list-style-type: none"> Stainless steel body and base, inox AISI 316. Tempered protection glass. 	SCUBA DE TWO WAY (WALL LIGHTING)						
									
<table border="1"> <thead> <tr> <th>CODE</th> <th>DESCRIPTION</th> <th>COLOUR</th> </tr> </thead> <tbody> <tr> <td>852615</td> <td>271750 GU10 2x max. 35W PAR 16 / GU10</td> <td>Inox</td> </tr> </tbody> </table>			CODE	DESCRIPTION	COLOUR	852615	271750 GU10 2x max. 35W PAR 16 / GU10	Inox	PRICE LIST
CODE	DESCRIPTION	COLOUR							
852615	271750 GU10 2x max. 35W PAR 16 / GU10	Inox							

 <p>Beam 40°</p>			 OSRAM: HALOPIN PHILIPS: CLICKLINE  MEGAMAN: CFL G9 <ul style="list-style-type: none"> Aluminium body Transparent protection glass. Aluminium beam distribution component. 	BEAM 1 - ONE WAY IP65 (WALL LIGHTING)											
			 												
<table border="1"> <thead> <tr> <th>CODE</th> <th>DESCRIPTION</th> <th>COLOUR</th> </tr> </thead> <tbody> <tr> <td>85727</td> <td>BEAM1 - ONE WAY IP65 beam 40° 1x max.60W QT 14 or 7W CFL / G9</td> <td>White, Titan, Black</td> </tr> <tr> <td>85727</td> <td>BEAM1 - ONE WAY IP65 beam 40° 1x max.60W QT 14 or 7W CFL / G9</td> <td>Chrome, matt Alum.</td> </tr> <tr> <td>857270</td> <td>BEAM1 - ONE WAY IP65 beam 40° 1x max.60W QT 14 or 7W CFL / G9</td> <td>Colours</td> </tr> </tbody> </table>			CODE	DESCRIPTION	COLOUR	85727	BEAM1 - ONE WAY IP65 beam 40° 1x max.60W QT 14 or 7W CFL / G9	White, Titan, Black	85727	BEAM1 - ONE WAY IP65 beam 40° 1x max.60W QT 14 or 7W CFL / G9	Chrome, matt Alum.	857270	BEAM1 - ONE WAY IP65 beam 40° 1x max.60W QT 14 or 7W CFL / G9	Colours	PRICE LIST
CODE	DESCRIPTION	COLOUR													
85727	BEAM1 - ONE WAY IP65 beam 40° 1x max.60W QT 14 or 7W CFL / G9	White, Titan, Black													
85727	BEAM1 - ONE WAY IP65 beam 40° 1x max.60W QT 14 or 7W CFL / G9	Chrome, matt Alum.													
857270	BEAM1 - ONE WAY IP65 beam 40° 1x max.60W QT 14 or 7W CFL / G9	Colours													

 <p>Beam 100°</p>			 OSRAM: HALOPIN PHILIPS: CLICKLINE  MEGAMAN: CFL G9 <ul style="list-style-type: none"> Aluminium body Transparent protection glass. Aluminium beam distribution component. 	BEAM 1 - ONE WAY IP65 (WALL LIGHTING)											
			 												
<table border="1"> <thead> <tr> <th>CODE</th> <th>DESCRIPTION</th> <th>COLOUR</th> </tr> </thead> <tbody> <tr> <td>85728</td> <td>BEAM1 - ONE WAY IP65 beam 100° 1x max.60W QT 14 or 7W CFL / G9</td> <td>White, Titan, Black</td> </tr> <tr> <td>85728</td> <td>BEAM1 - ONE WAY IP65 beam 100° 1x max.60W QT 14 or 7W CFL / G9</td> <td>Chrome, matt Alum.</td> </tr> <tr> <td>857280</td> <td>BEAM1 - ONE WAY IP65 beam 100° 1x max.60W QT 14 or 7W CFL / G9</td> <td>Colours</td> </tr> </tbody> </table>			CODE	DESCRIPTION	COLOUR	85728	BEAM1 - ONE WAY IP65 beam 100° 1x max.60W QT 14 or 7W CFL / G9	White, Titan, Black	85728	BEAM1 - ONE WAY IP65 beam 100° 1x max.60W QT 14 or 7W CFL / G9	Chrome, matt Alum.	857280	BEAM1 - ONE WAY IP65 beam 100° 1x max.60W QT 14 or 7W CFL / G9	Colours	PRICE LIST
CODE	DESCRIPTION	COLOUR													
85728	BEAM1 - ONE WAY IP65 beam 100° 1x max.60W QT 14 or 7W CFL / G9	White, Titan, Black													
85728	BEAM1 - ONE WAY IP65 beam 100° 1x max.60W QT 14 or 7W CFL / G9	Chrome, matt Alum.													
857280	BEAM1 - ONE WAY IP65 beam 100° 1x max.60W QT 14 or 7W CFL / G9	Colours													



Beam 40° / 100°

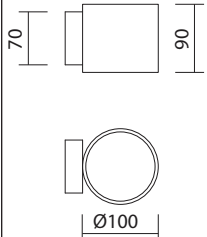

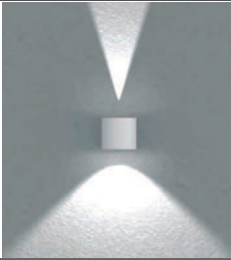

QT 14 OSRAM: HALOPIN
G9 PHILIPS: CLICKLINE

MEGAMAN: CFL G9

- Aluminium body.
- Transparent protection glass.
- Aluminium beam distribution component.

BEAM 1 - TWO WAY IP65
(WALL LIGHTING)

CE F IP 65

850°C

CODE	DESCRIPTION	COLOUR
85721	BEAM1 - TWO WAY IP65 Beam 40° / 100° 1x max.60W QT 14 or 7W CFL / G9	White, Titan, Black
85721	BEAM1 - TWO WAY IP65 Beam 40° / 100° 1x max.60W QT 14 or 7W CFL / G9	Chrome, matt Alum.
857210	BEAM1 - TWO WAY IP65 Beam 40° / 100° 1x max.60W QT 14 or 7W CFL / G9	Colours



Beam 100° / 100°

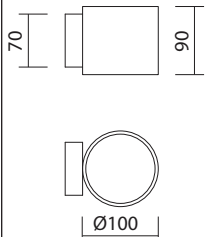

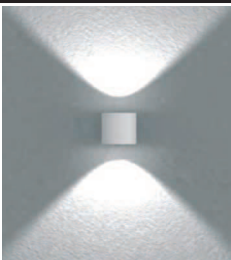

QT 14 OSRAM: HALOPIN
G9 PHILIPS: CLICKLINE

MEGAMAN: CFL G9

- Aluminium body.
- Transparent protection glass.
- Aluminium beam distribution component.

BEAM 1 - TWO WAY IP65
(WALL LIGHTING)

CE F IP 65

850°C

CODE	DESCRIPTION	COLOUR
85722	BEAM1 - TWO WAY IP65 Beam 100° / 100° 1x max.60W QT 14 or 7W CFL / G9	White, Titan, Black
85722	BEAM1 - TWO WAY IP65 Beam 100° / 100° 1x max.60W QT 14 or 7W CFL / G9	Chrome, matt Alum.
857220	BEAM1 - TWO WAY IP65 Beam 100° / 100° 1x max.60W QT 14 or 7W CFL / G9	Colours



Beam 40° / 40°

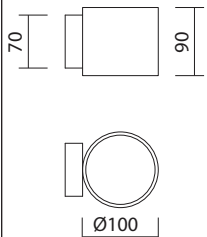

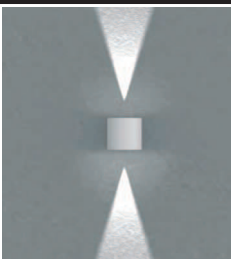

QT 14 OSRAM: HALOPIN
G9 PHILIPS: CLICKLINE

MEGAMAN: CFL G9

- Aluminium body.
- Transparent protection glass.
- Aluminium beam distribution component.

BEAM 1 - TWO WAY IP65
(WALL LIGHTING)

CE F IP 65

850°C

CODE	DESCRIPTION	COLOUR
85723	BEAM1 - TWO WAY IP65 Beam 40° / 40° 1x max.60W QT 14 or 7W CFL / G9	White, Titan, Black
85723	BEAM1 - TWO WAY IP65 Beam 40° / 40° 1x max.60W QT 14 or 7W CFL / G9	Chrome, matt Alum.
857230	BEAM1 - TWO WAY IP65 Beam 40° / 40° 1x max.60W QT 14 or 7W CFL / G9	Colours

Colour Codes:

0 Colours 1 White 2 Titan 3 Black 4 Chrome 5 matt Alum.

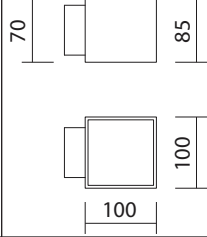
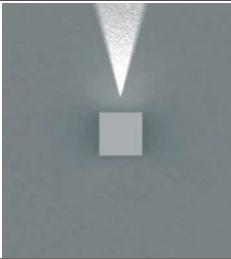
 <p>Beam 40°</p>			<p>QT 14 OSRAM: HALOPIN G9 PHILIPS: CLICKLINE</p> <p>MEGAMAN: CFL G9</p> <ul style="list-style-type: none"> Aluminium body. Transparent protection glass. Aluminium beam distribution component. 	<p>BEAM 2 - ONE WAY IP65 (WALL LIGHTING)</p>
				<p>CE F IP 65</p> <p>850°C</p>
<p style="text-align: right;">PRICE LIST</p>				
CODE	DESCRIPTION		COLOUR	
85729	BEAM2 - ONE WAY IP65	Beam 40° 1x max.60W QT 14 or 7W CFL / G9	White, Titan, Black	
85729	BEAM2 - ONE WAY IP65	Beam 40° 1x max.60W QT 14 or 7W CFL / G9	Chrome, matt Alum.	
857290	BEAM2 - ONE WAY IP65	Beam 40° 1x max.60W QT 14 or 7W CFL / G9	Colours	

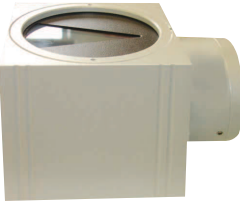
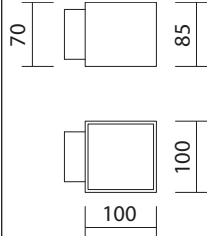
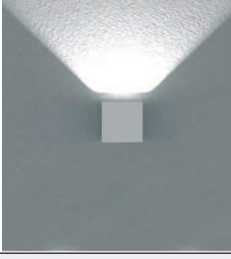
 <p>Beam 100°</p>			<p>QT 14 OSRAM: HALOPIN G9 PHILIPS: CLICKLINE</p> <p>MEGAMAN: CFL G9</p> <ul style="list-style-type: none"> Aluminium body. Transparent protection glass. Aluminium beam distribution component. 	<p>BEAM 2 - ONE WAY IP65 (WALL LIGHTING)</p>
				<p>CE F IP 65</p> <p>850°C</p>
<p style="text-align: right;">PRICE LIST</p>				
CODE	DESCRIPTION		COLOUR	
85730	BEAM2 - ONE WAY IP65	Beam 100° 1x max.60W QT 14 or 7W CFL / G9	White, Titan, Black	
85730	BEAM2 - ONE WAY IP65	Beam 100° 1x max.60W QT 14 or 7W CFL / G9	Chrome, matt Alum.	
857300	BEAM2 - ONE WAY IP65	Beam 100° 1x max.60W QT 14 or 7W CFL / G9	Colours	





Beam 40° / 100°

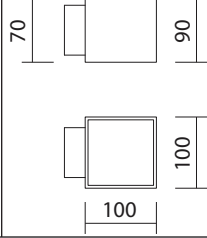

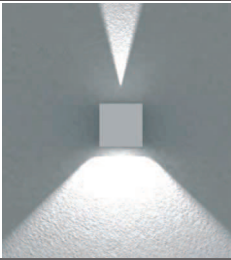

QT 14 OSRAM: HALOPIN
PHILIPS: CLICKLINE

G9 MEGAMAN: CFL G9

- Aluminium body.
- Transparent protection glass.
- Aluminium beam distribution component.

BEAM 2 - TWO WAY IP65
(WALL LIGHTING)

CE F IP 65

850°C

PRICE LIST				
CODE	DESCRIPTION	COLOUR		
85724	BEAM2 - TWO WAY IP65 Beam 40° / 100°	White, Titan, Black	1x max.60W QT 14 or 7W CFL / G9	
85724	BEAM2 - TWO WAY IP65 Beam 40° / 100°	Chrome, matt Alum.	1x max.60W QT 14 or 7W CFL / G9	
857240	BEAM2 - TWO WAY IP65 Beam 40° / 100°	Colours	1x max.60W QT 14 or 7W CFL / G9	

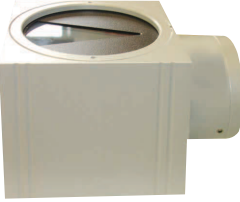

Beam 100° / 100°

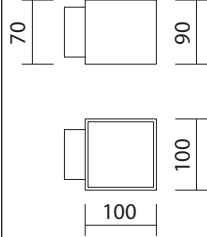

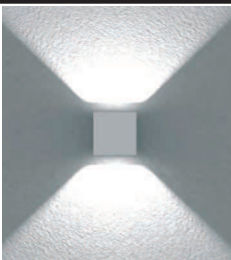

QT 14 OSRAM: HALOPIN
PHILIPS: CLICKLINE

G9 MEGAMAN: CFL G9

- Aluminium body.
- Transparent protection glass.
- Aluminium beam distribution component.

BEAM 2 - TWO WAY IP65
(WALL LIGHTING)

CE F IP 65

850°C

PRICE LIST				
CODE	DESCRIPTION	COLOUR		
85725	BEAM2 - TWO WAY IP65 Beam 100° / 100°	White, Titan, Black	1x max.60W QT 14 or 7W CFL / G9	
85725	BEAM2 - TWO WAY IP65 Beam 100° / 100°	Chrome, matt Alum.	1x max.60W QT 14 or 7W CFL / G9	
857250	BEAM2 - TWO WAY IP65 Beam 100° / 100°	Colours	1x max.60W QT 14 or 7W CFL / G9	

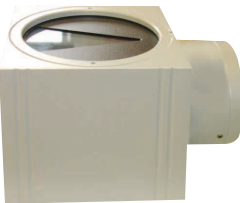

Beam 40° / 40°

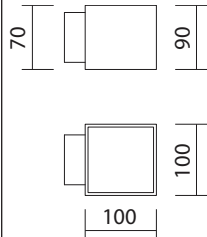

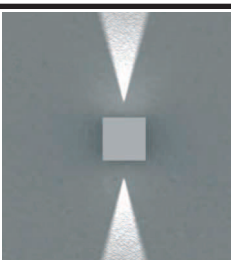

QT 14 OSRAM: HALOPIN
PHILIPS: CLICKLINE

G9 MEGAMAN: CFL G9

- Aluminium body.
- Transparent protection glass.
- Aluminium beam distribution component.

BEAM 2 - TWO WAY IP65
(WALL LIGHTING)



CE F IP 65



850°C

PRICE LIST				
CODE	DESCRIPTION	COLOUR		
85726	BEAM2 - TWO WAY IP65 Beam 40° / 40°	White, Titan, Black	1x max.60W QT 14 or 7W CFL / G9	
85726	BEAM2 - TWO WAY IP65 Beam 40° / 40°	Chrome, matt Alum.	1x max.60W QT 14 or 7W CFL / G9	
857260	BEAM2 - TWO WAY IP65 Beam 40° / 40°	Colours	1x max.60W QT 14 or 7W CFL / G9	

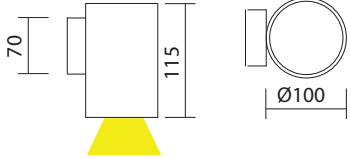
Colour Codes:

0 Colours 1 White 2 Titan 3 Black 4 Chrome 5 matt Alum.

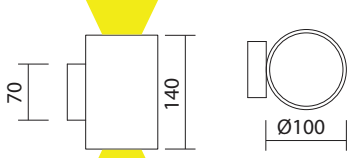
		<ul style="list-style-type: none"> Aluminium body. Beam distribution lens. 	BEAM 3 - ONE WAY (WALL LIGHTING LED)	
			CE, F, IP 65, 850°C, 	
			PRICE LIST	
CODE	DESCRIPTION	LED COLOUR	BEAMS	BODY COLOUR
85731	BEAM3 ONE WAY 3 LED x 1W (Integrated Control Gear)	Selection from table A	Selection from table B	White, Titan, Black
85731	BEAM3 ONE WAY 3 LED x 1W (Integrated Control Gear)	Selection from table A	Selection from table B	Chrome, matt Alum.
85731	BEAM3 ONE WAY 3 LED x 1W (Integrated Control Gear)	Selection from table A	Selection from table B	Colours
85732	BEAM3 ONE WAY 3 LED x 2W (Integrated Control Gear)	Selection from table A	Selection from table B	White, Titan, Black
85732	BEAM3 ONE WAY 3 LED x 2W (Integrated Control Gear)	Selection from table A	Selection from table B	Chrome, matt Alum.
85732	BEAM3 ONE WAY 3 LED x 2W (Integrated Control Gear)	Selection from table A	Selection from table B	Colours

		<ul style="list-style-type: none"> Aluminium body. Beam distribution lens. 	BEAM 3 - TWO WAY (WALL LIGHTING LED)	
			CE, F, IP 65, 850°C, 	
			PRICE LIST	
CODE	DESCRIPTION	LED COLOUR	BEAMS	BODY COLOUR
85736	BEAM3 3+3 LED x 1W (Integrated Control Gear)	Selection from table A	Selection from table B	White, Titan, Black
85736	BEAM3 3+3 LED x 1W (Integrated Control Gear)	Selection from table A	Selection from table B	Chrome, matt Alum.
85736	BEAM3 3+3 LED x 1W (Integrated Control Gear)	Selection from table A	Selection from table B	Colours
85737	BEAM3 3+3 LED x 2W (Integrated Control Gear)	Selection from table A	Selection from table B	White, Titan, Black
85737	BEAM3 3+3 LED x 2W (Integrated Control Gear)	Selection from table A	Selection from table B	Chrome, matt Alum.
85737	BEAM3 3+3 LED x 2W (Integrated Control Gear)	Selection from table A	Selection from table B	Colours

A Led Colour:
2 Warm 3 Neutral



B Beams Codes:
10 narrow/narrow 30 wide/wide 45 super-wide/super-wide 90 narrow/wide 91 narrow/super-wide 92 wide/super-wide

C Colour Codes:
0 Colours 1 White 2 Titan 3 Black 4 Chrome 5 matt Alum.

		<ul style="list-style-type: none"> Aluminium body. Beam distribution lens. 	BEAM 4 - ONE WAY (WALL LIGHTING LED)		
PRICE LIST					
CODE	DESCRIPTION	LED COLOUR	BEAMS	BODY COLOUR	
85741	BEAM4 ONE WAY 3 LED x 1W (Integrated Control Gear)	Selection from table A	Selection from table B	White, Titan, Black	
85741	BEAM4 ONE WAY 3 LED x 1W (Integrated Control Gear)	Selection from table A	Selection from table B	Chrome, matt Alum.	
85741	BEAM4 ONE WAY 3 LED x 1W (Integrated Control Gear)	Selection from table A	Selection from table B	Colours	
85742	BEAM4 ONE WAY 3 LED x 2W (Integrated Control Gear)	Selection from table A	Selection from table B	White, Titan, Black	
85742	BEAM4 ONE WAY 3 LED x 2W (Integrated Control Gear)	Selection from table A	Selection from table B	Chrome, matt Alum.	
85742	BEAM4 ONE WAY 3 LED x 2W (Integrated Control Gear)	Selection from table A	Selection from table B	Colours	







		<ul style="list-style-type: none"> Aluminium body. Beam distribution lens. 	BEAM 4 - TWO WAY (WALL LIGHTING LED)		
PRICE LIST					
CODE	DESCRIPTION	LED COLOUR	BEAMS	BODY COLOUR	
85746	BEAM4 3+3 LED x 1W (Integrated Control Gear)	Selection from table A	Selection from table B	White, Titan, Black	
85746	BEAM4 3+3 LED x 1W (Integrated Control Gear)	Selection from table A	Selection from table B	Chrome, matt Alum.	
85746	BEAM4 3+3 LED x 1W (Integrated Control Gear)	Selection from table A	Selection from table B	Colours	
85747	BEAM4 3+3 LED x 2W (Integrated Control Gear)	Selection from table A	Selection from table B	White, Titan, Black	
85747	BEAM4 3+3 LED x 2W (Integrated Control Gear)	Selection from table A	Selection from table B	Chrome, matt Alum.	
85747	BEAM4 3+3 LED x 2W (Integrated Control Gear)	Selection from table A	Selection from table B	Colours	

Led Colour:
2 Warm 3 Neutral

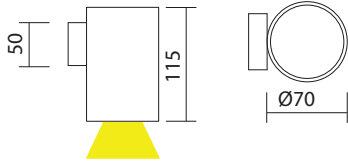





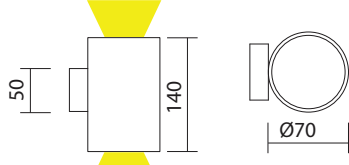

Beams Codes:
10 narrow/narrow 30 wide/wide 45 super-wide/super-wide 90 narrow/wide 91 narrow/super-wide 92 wide/super-wide

Colour Codes:
0 Colours 1 White 2 Titan 3 Black 4 Chrome 5 matt Alum.

		<ul style="list-style-type: none"> Aluminium body. Beam distribution lens. 	BEAM 5 - ONE WAY (WALL LIGHTING LED)
			    

PRICE LIST					
CODE	DESCRIPTION	LED COLOUR	BEAMS	BODY COLOUR	
85751	BEAM5 ONE WAY 3 LED x 1W (Integrated Control Gear)	Selection from table A	Selection from table B	White, Titan, Black	
85751	BEAM5 ONE WAY 3 LED x 1W (Integrated Control Gear)	Selection from table A	Selection from table B	Chrome, matt Alum.	
85751	BEAM5 ONE WAY 3 LED x 1W (Integrated Control Gear)	Selection from table A	Selection from table B	Colours	
85752	BEAM5 ONE WAY 3 LED x 2W (Integrated Control Gear)	Selection from table A	Selection from table B	White, Titan, Black	
85752	BEAM5 ONE WAY 3 LED x 2W (Integrated Control Gear)	Selection from table A	Selection from table B	Chrome, matt Alum.	
85752	BEAM5 ONE WAY 3 LED x 2W (Integrated Control Gear)	Selection from table A	Selection from table B	Colours	

		<ul style="list-style-type: none"> Aluminium body. Beam distribution lens. 	BEAM 5 - TWO WAY (WALL LIGHTING LED)
			    

PRICE LIST					
CODE	DESCRIPTION	LED COLOUR	BEAMS	BODY COLOUR	
85756	BEAM5 TWO WAY 3+3LED x1W (Integrated Control Gear)	Selection from table A	Selection from table B	White, Titan, Black	
85756	BEAM5 TWO WAY 3+3LED x1W (Integrated Control Gear)	Selection from table A	Selection from table B	Chrome, matt Alum.	
85756	BEAM5 TWO WAY 3+3LED x1W (Integrated Control Gear)	Selection from table A	Selection from table B	Colours	
85757	BEAM5 TWO WAY 3+3LED x2W (Integrated Control Gear)	Selection from table A	Selection from table B	White, Titan, Black	
85757	BEAM5 TWO WAY 3+3LED x2W (Integrated Control Gear)	Selection from table A	Selection from table B	Chrome, matt Alum.	
85757	BEAM5 TWO WAY 3+3LED x2W (Integrated Control Gear)	Selection from table A	Selection from table B	Colours	

A Led Colour:
2 Warm 3 Neutral



B Beams Codes:
10 narrow/narrow 30 wide/wide 45 super-wide/super-wide 90 narrow/wide 91 narrow/super-wide 92 wide/super-wide

C Colour Codes:
0 Colours 1 White 2 Titan 3 Black 4 Chrome 5 matt Alum.

		<ul style="list-style-type: none"> Aluminium body. Beam distribution lens. 	BEAM 6 - ONE WAY (WALL LIGHTING LED)

						PRICE LIST
CODE	DESCRIPTION	LED COLOUR	BEAMS	BODY COLOUR		
85761	BEAM6 ONE WAY 3 LED x 1W (Integrated Control Gear)	Selection from table A	Selection from table B	White, Titan, Black		
85761	BEAM6 ONE WAY 3 LED x 1W (Integrated Control Gear)	Selection from table A	Selection from table B	Chrome, matt Alum.		
85761	BEAM6 ONE WAY 3 LED x 1W (Integrated Control Gear)	Selection from table A	Selection from table B	Colours		
85762	BEAM6 ONE WAY 3 LED x 2W (Integrated Control Gear)	Selection from table A	Selection from table B	White, Titan, Black		
85762	BEAM6 ONE WAY 3 LED x 2W (Integrated Control Gear)	Selection from table A	Selection from table B	Chrome, matt Alum.		
85762	BEAM6 ONE WAY 3 LED x 2W (Integrated Control Gear)	Selection from table A	Selection from table B	Colours		

		<ul style="list-style-type: none"> Aluminium body. Beam distribution lens. 	BEAM 6 - TWO WAY (WALL LIGHTING LED)



						PRICE LIST
CODE	DESCRIPTION	LED COLOUR	BEAMS	BODY COLOUR		
85766	BEAM6 TWO WAY 3+3LED x1W (Integrated Control Gear)	Selection from table A	Selection from table B	White, Titan, Black		
85766	BEAM6 TWO WAY 3+3LED x1W (Integrated Control Gear)	Selection from table A	Selection from table B	Chrome, matt Alum.		
85766	BEAM6 TWO WAY 3+3LED x1W (Integrated Control Gear)	Selection from table A	Selection from table B	Colours		
85767	BEAM6 TWO WAY 3+3LED x2W (Integrated Control Gear)	Selection from table A	Selection from table B	White, Titan, Black		
85767	BEAM6 TWO WAY 3+3LED x2W (Integrated Control Gear)	Selection from table A	Selection from table B	Chrome, matt Alum.		
85767	BEAM6 TWO WAY 3+3LED x2W (Integrated Control Gear)	Selection from table A	Selection from table B	Colours		

A Led Colour:
2 Warm 3 Neutral

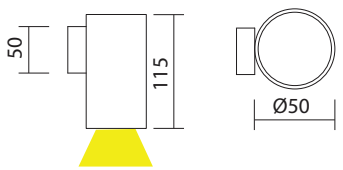

B Beams Codes:
10 narrow/narrow 30 wide/wide 45 super-wide/super-wide 90 narrow/wide 91 narrow/super-wide 92 wide/super-wide

C Colour Codes:
0 Colours 1 White 2 Titan 3 Black 4 Chrome 5 matt Alum.



				<p>BEAM 7 - ONE WAY (WALL LIGHTING LED)</p>	
				<p>• Aluminium body. • Beam distribution lens.</p>	
				<p>CE, F, IP 65, 850°C, </p>	
					PRICE LIST
CODE	DESCRIPTION	LED COLOUR	BEAMS	BODY COLOUR	
85770	BEAM7 ONE WAY 1 LED x 1W (Integrated Control Gear)	Selection from table A	Selection from table D	White, Titan, Black	
85770	BEAM7 ONE WAY 1 LED x 1W (Integrated Control Gear)	Selection from table A	Selection from table D	Chrome, matt Alum.	
85770	BEAM7 ONE WAY 1 LED x 1W (Integrated Control Gear)	Selection from table A	Selection from table D	Colours	
85771	BEAM7 ONE WAY 1 LED x 2W (Integrated Control Gear)	Selection from table A	Selection from table D	White, Titan, Black	
85771	BEAM7 ONE WAY 1 LED x 2W (Integrated Control Gear)	Selection from table A	Selection from table D	Chrome, matt Alum.	
85771	BEAM7 ONE WAY 1 LED x 2W (Integrated Control Gear)	Selection from table A	Selection from table D	Colours	

A Led Colour:
 2 Warm 3 Neutral

D Beams Codes:
 10 narrow 30 wide 45 super-wide 00 120°

C Colour Codes:
 0 Colours 1 White 2 Titan 3 Black 4 Chrome 5 matt Alum.

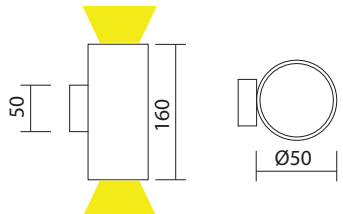

				<p>BEAM 7 - TWO WAY (WALL LIGHTING LED)</p>	
				<p>• Aluminium body. • Beam distribution lens.</p>	
				<p>CE, F, IP 65, 850°C, </p>	
					PRICE LIST
CODE	DESCRIPTION	LED COLOUR	BEAMS	BODY COLOUR	
85776	BEAM7 TWO WAY 1+1 LED x 1W (Integrated Control Gear)	Selection from table A	Selection from table B	White, Titan, Black	
85776	BEAM7 TWO WAY 1+1 LED x 1W (Integrated Control Gear)	Selection from table A	Selection from table B	Chrome, matt Alum.	
85776	BEAM7 TWO WAY 1+1 LED x 1W (Integrated Control Gear)	Selection from table A	Selection from table B	Colours	
85777	BEAM7 TWO WAY 1+1 LED x 2W (Integrated Control Gear)	Selection from table A	Selection from table B	White, Titan, Black	
85777	BEAM7 TWO WAY 1+1 LED x 2W (Integrated Control Gear)	Selection from table A	Selection from table B	Chrome, matt Alum.	
85777	BEAM7 TWO WAY 1+1 LED x 2W (Integrated Control Gear)	Selection from table A	Selection from table B	Colours	

A Led Colour:
 2 Warm 3 Neutral

B Beams Codes:
 10 narrow/narrow 30 wide/wide 45 super-wide/super-wide 90 narrow/wide 91 narrow/super-wide 92 wide/super-wide
 93 narrow/120° 94 wide/120° 95 super-wide/120° 00 120°/120°

C Colour Codes:
 0 Colours 1 White 2 Titan 3 Black 4 Chrome 5 matt Alum.



QT 14 OSRAM: HALOPIN
G9 PHILIPS: CLICKLINE

- Die-cast aluminium body.
- Refractive clear glass

LEO 80
Beam 4°
(WALL LIGHTING)

CODE	DESCRIPTION	COLOUR	
850351	LEO 80 - 4011E beam 4° 1x40W QT14 / G9	White	PRICE LIST
850353	LEO 80 - 4016E beam 4° 1x40W QT14 / G9	Anthracite	
850352	LEO 80 - 4017E beam 4° 1x40W QT14 / G9	Grey	

QT 14 OSRAM: HALOPIN
G9 PHILIPS: CLICKLINE

- Die-cast aluminium body.
- Refractive clear glass

LEO 80
Beam 35°
(WALL LIGHTING)

CODE	DESCRIPTION	COLOUR	
850361	LEO 80 - 4011B beam 35° 1x40W QT14 / G9	White	PRICE LIST
850363	LEO 80 - 4016B beam 35° 1x40W QT14 / G9	Anthracite	
850362	LEO 80 - 4017B beam 35° 1x40W QT14 / G9	Grey	

QT 14 OSRAM: HALOPIN
G9 PHILIPS: CLICKLINE

- Die-cast aluminium body.
- Refractive clear glass

LEO 80
Beam 4° / 4°
(WALL LIGHTING)

CODE	DESCRIPTION	COLOUR	
850371	LEO 80 - 4021E beam 4° / 4° 1x40W QT14 / G9	White	PRICE LIST
850373	LEO 80 - 4026E beam 4° / 4° 1x40W QT14 / G9	Anthracite	
850372	LEO 80 - 4027E beam 4° / 4° 1x40W QT14 / G9	Grey	

QT 14 OSRAM: HALOPIN
G9 PHILIPS: CLICKLINE



- Die-cast aluminium body.
- Refractive clear glass



LEO 80
Beam 4° / 35°
(WALL LIGHTING)

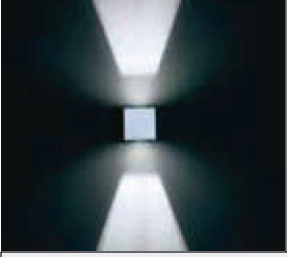
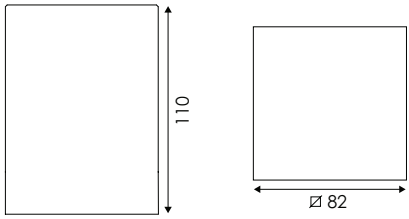

CODE	DESCRIPTION	COLOUR	
850381	LEO 80 - 4001EB beam 4° / 35° 1x40W QT14 / G9	White	PRICE LIST
850383	LEO 80 - 4006EB beam 4° / 35° 1x40W QT14 / G9	Anthracite	
850382	LEO 80 - 4007EB beam 4° / 35° 1x40W QT14 / G9	Grey	

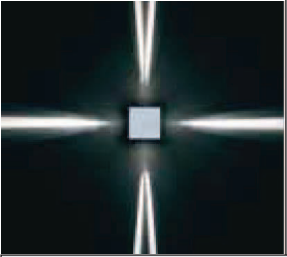
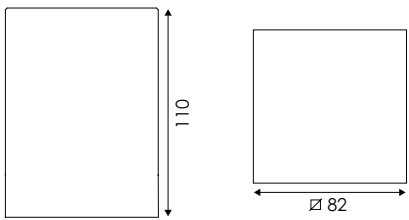

To ensure the degree of protection use only suitable flexible cables like the class H07RN-F or similar.

		 OSRAM: HALOPIN PHILIPS: CLICKLINE	LEO 80 Beam 35° / 35° (WALL LIGHTING)
PRICE LIST			
CODE	DESCRIPTION	COLOUR	
850391	LEO 80 - 4021B beam 35° / 35° 1x40W QT14 / G9	White	
850393	LEO 80 - 4026B beam 35° / 35° 1x40W QT14 / G9	Anthracite	
850392	LEO 80 - 4027B beam 35° / 35° 1x40W QT14 / G9	Grey	

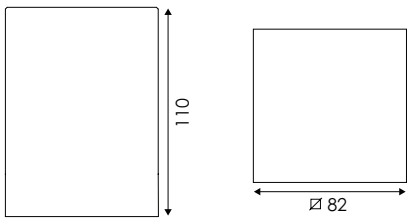
		 OSRAM: HALOPIN PHILIPS: CLICKLINE	LEO 80 Beam 4° / 4° (WALL LIGHTING)
PRICE LIST			
CODE	DESCRIPTION	COLOUR	
850401	LEO 80 - 4041E beam 4° / 4° 1x40W QT14 / G9	White	
850403	LEO 80 - 4046E beam 4° / 4° 1x40W QT14 / G9	Anthracite	
850402	LEO 80 - 4047E beam 4° / 4° 1x40W QT14 / G9	Grey	

		 OSRAM: HALOPIN PHILIPS: CLICKLINE	LEO 80 Beam 35° / 35° (WALL LIGHTING)
PRICE LIST			
CODE	DESCRIPTION	COLOUR	
850411	LEO 80 - 4041B beam 35° / 35° 1x40W QT14 / G9	White	
850413	LEO 80 - 4046B beam 35° / 35° 1x40W QT14 / G9	Anthracite	
850412	LEO 80 - 4047B beam 35° / 35° 1x40W QT14 / G9	Grey	



To ensure the degree of protection use only suitable flexible cables like the class H07RN-F or similar.



				<p>HIT-TC-CE OSRAM: HCI-TF GU6,5 PHILIPS: -</p> <p>TC-TEL OSRAM: DULUX T / E PHILIPS: PL-T / 4P</p>	<p>LEO 120 Beam 4° (WALL LIGHTING)</p> <p>CE F IP 65</p>
				PRICE LIST	
CODE	DESCRIPTION			COLOUR	
850421	LEO 120 - 2011E	beam 4°	1x20W HIT-TC-CE / GU6,5	White	
850423	LEO 120 - 2016E	beam 4°	1x20W HIT-TC-CE / GU6,5	Anthracite	
850422	LEO 120 - 2017E	beam 4°	1x20W HIT-TC-CE / GU6,5	Grey	





				<p>HIT-TC-CE OSRAM: HCI-TF GU6,5 PHILIPS: -</p> <p>TC-TEL OSRAM: DULUX T / E PHILIPS: PL-T / 4P</p>	<p>LEO 120 Beam 35° (WALL LIGHTING)</p> <p>CE F IP 65</p>
				PRICE LIST	
CODE	DESCRIPTION			COLOUR	
850431	LEO 120 - 2011B	beam 35°	1x20W HIT-TC-CE / GU6,5	White	
850433	LEO 120 - 2016B	beam 35°	1x20W HIT-TC-CE / GU6,5	Anthracite	
850432	LEO 120 - 2017B	beam 35°	1x20W HIT-TC-CE / GU6,5	Grey	



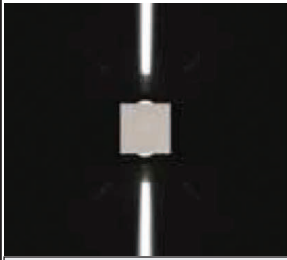
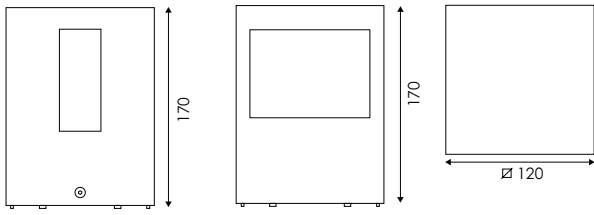

				<p>HIT-TC-CE OSRAM: HCI-TF GU6,5 PHILIPS: -</p>	<p>LEO 120 Beam 75° (WALL LIGHTING)</p> <p>CE F IP 65</p>
				PRICE LIST	
CODE	DESCRIPTION			COLOUR	
850441	LEO 120 - 2011F	beam 75°	1x20W HIT-TC-CE / GU6,5	White	
850443	LEO 120 - 2016F	beam 75°	1x20W HIT-TC-CE / GU6,5	Anthracite	
850442	LEO 120 - 2017F	beam 75°	1x20W HIT-TC-CE / GU6,5	Grey	



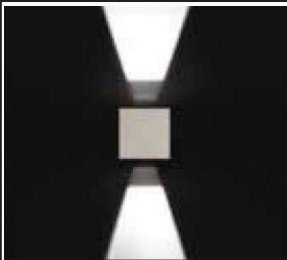
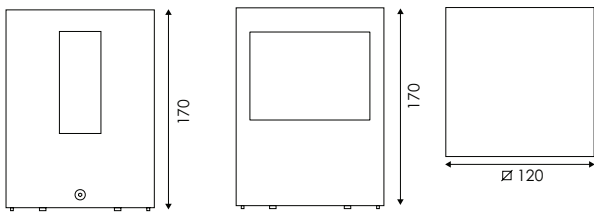

				<p>TC-TEL OSRAM: DULUX T / E PHILIPS: PL-T / 4P</p>	<p>LEO 120 Beam 75° (WALL LIGHTING)</p> <p>CE F IP 65</p>
				PRICE LIST	
CODE	DESCRIPTION			COLOUR	
850451	LEO 120 - 1311F	beam 75°	1x13W TC-TEL / GX24q-1	White	
850453	LEO 120 - 1316F	beam 75°	1x13W TC-TEL / GX24q-1	Anthracite	
850452	LEO 120 - 1317F	beam 75°	1x13W TC-TEL / GX24q-1	Grey	





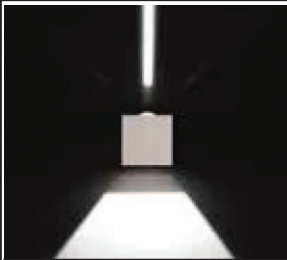
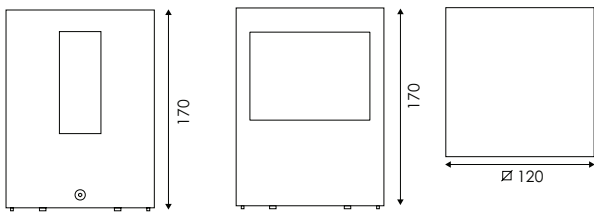

To ensure the degree of protection use only suitable flexible cables like the class H07RN-F or similar.

		<p>HIT-TC-CE OSRAM: HCI-TF GU6,5 PHILIPS: -</p> <p>TC-TEL OSRAM: DULUX T / E PHILIPS: PL-T / 4P</p> <p>• Die-cast aluminium body. • Refractive clear glass</p>	<p>LEO 120 Beam 4° / 4° (WALL LIGHTING)</p> <p>  </p>
PRICE LIST			
CODE	DESCRIPTION	COLOUR	
850461	LEO 120 - 2021E beam 4° / 4° 1x20W HIT-TC-CE / GU6,5	White	
850463	LEO 120 - 2026E beam 4° / 4° 1x20W HIT-TC-CE / GU6,5	Anthracite	
850462	LEO 120 - 2027E beam 4° / 4° 1x20W HIT-TC-CE / GU6,5	Grey	

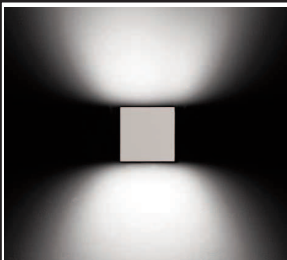
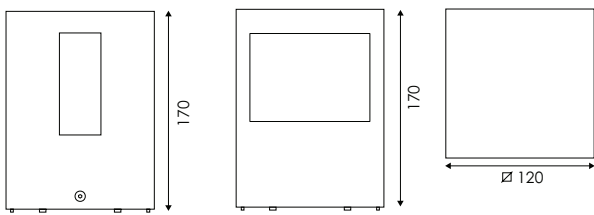
		<p>HIT-TC-CE OSRAM: HCI-TF GU6,5 PHILIPS: -</p> <p>TC-TEL OSRAM: DULUX T / E PHILIPS: PL-T / 4P</p> <p>• Die-cast aluminium body. • Refractive clear glass</p>	<p>LEO 120 Beam 35° / 35° (WALL LIGHTING)</p> <p>  </p>
PRICE LIST			
CODE	DESCRIPTION	COLOUR	
850471	LEO 120 - 2021B beam 35° / 35° 1x20W HIT-TC-CE / GU6,5	White	
850473	LEO 120 - 2026B beam 35° / 35° 1x20W HIT-TC-CE / GU6,5	Anthracite	
850472	LEO 120 - 2027B beam 35° / 35° 1x20W HIT-TC-CE / GU6,5	Grey	

		<p>HIT-TC-CE OSRAM: HCI-TF GU6,5 PHILIPS: -</p> <p>TC-TEL OSRAM: DULUX T / E PHILIPS: PL-T / 4P</p> <p>• Die-cast aluminium body. • Refractive clear glass</p>	<p>LEO 120 Beam 4° / 75° (WALL LIGHTING)</p> <p>  </p>
PRICE LIST			
CODE	DESCRIPTION	COLOUR	
850481	LEO 120 - 2001EF beam 4° / 75° 1x20W HIT-TC-CE / GU6,5	White	
850483	LEO 120 - 2006EF beam 4° / 75° 1x20W HIT-TC-CE / GU6,5	Anthracite	
850482	LEO 120 - 2007EF beam 4° / 75° 1x20W HIT-TC-CE / GU6,5	Grey	

		<p>HIT-TC-CE OSRAM: HCI-TF GU6,5 PHILIPS: -</p> <p>• Die-cast aluminium body. • Refractive clear glass</p>	<p>LEO 120 Beam 75° / 75° (WALL LIGHTING)</p> <p>  </p>
PRICE LIST			
CODE	DESCRIPTION	COLOUR	
850491	LEO 120 - 2021F beam 75° / 75° 1x20W HIT-TC-CE / GU6,5	White	
850493	LEO 120 - 2026F beam 75° / 75° 1x20W HIT-TC-CE / GU6,5	Anthracite	
850492	LEO 120 - 2027F beam 75° / 75° 1x20W HIT-TC-CE / GU6,5	Grey	



To ensure the degree of protection use only suitable flexible cables like the class H07RN-F or similar.

				OSRAM: DULUX T / E PHILIPS: PL-T / 4P	LEO 120 Beam 75° / 75° (WALL LIGHTING)
PRICE LIST					
CODE	DESCRIPTION			COLOUR	
850501	LEO 120 - 1321F	beam 4° / 4°	1x13W TC-TEL / GX24q-1	White	
850503	LEO 120 - 1326F	beam 4° / 4°	1x13W TC-TEL / GX24q-1	Anthracite	
850502	LEO 120 - 1327F	beam 4° / 4°	1x13W TC-TEL / GX24q-1	Grey	



				OSRAM: HCI-TF PHILIPS: -	LEO 120 Beam 4° (WALL LIGHTING)
				OSRAM: DULUX T / E PHILIPS: PL-T / 4P	
PRICE LIST					
CODE	DESCRIPTION			COLOUR	
850511	LEO 120 - 2041E	beam 4°	1x20W HIT-TC-CE / GU6,5	White	
850513	LEO 120 - 2046E	beam 4°	1x20W HIT-TC-CE / GU6,5	Anthracite	
850512	LEO 120 - 2047E	beam 4°	1x20W HIT-TC-CE / GU6,5	Grey	



				OSRAM: HCI-TF PHILIPS: -	LEO 120 Beam 35° (WALL LIGHTING)
				OSRAM: DULUX T / E PHILIPS: PL-T / 4P	
PRICE LIST					
CODE	DESCRIPTION			COLOUR	
850521	LEO 120 - 2041B	beam 35°	1x20W HIT-TC-CE / GU6,5	White	
850523	LEO 120 - 2046B	beam 35°	1x20W HIT-TC-CE / GU6,5	Anthracite	
850522	LEO 120 - 2047B	beam 35°	1x20W HIT-TC-CE / GU6,5	Grey	

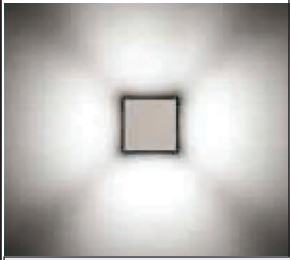
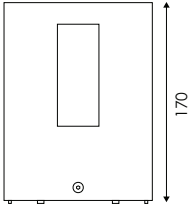
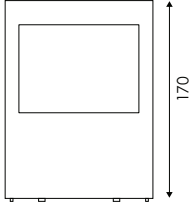
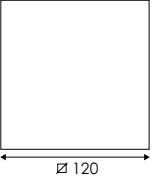

				OSRAM: HCI-TF PHILIPS: -	LEO 120 Beam 75° (WALL LIGHTING)
				• Die-cast aluminium body. • Refractive clear glass	
PRICE LIST					
CODE	DESCRIPTION			COLOUR	
850531	LEO 120 - 2041F	beam 75°	1x20W HIT-TC-CE / GU6,5	White	
850533	LEO 120 - 2046F	beam 75°	1x20W HIT-TC-CE / GU6,5	Anthracite	
850532	LEO 120 - 2047F	beam 75°	1x20W HIT-TC-CE / GU6,5	Grey	



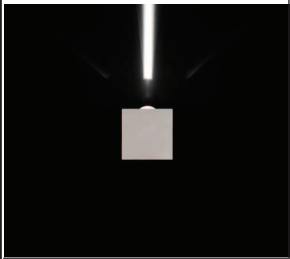
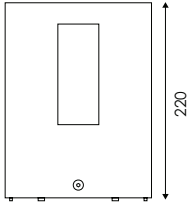
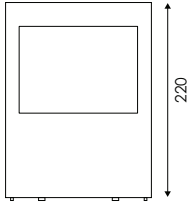
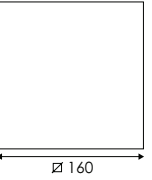

To ensure the degree of protection use only suitable flexible cables like the class H07RN-F or similar.

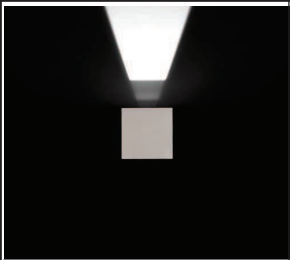
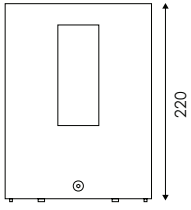
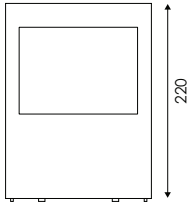
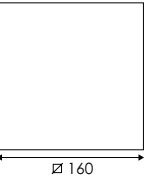
				 OSRAM: DULUX T / E PHILIPS: PL-T / 4P	LEO 120 Beam 75° (WALL LIGHTING)
					<ul style="list-style-type: none"> Die-cast aluminium body. Refractive clear glass
PRICE LIST					
CODE	DESCRIPTION			COLOUR	
850541	LEO 120 - 1341F	beam 75°	1x13W TC-TEL / GX24q-1	White	
850543	LEO 120 - 1346F	beam 75°	1x13W TC-TEL / GX24q-1	Anthracite	
850542	LEO 120 - 1347F	beam 75°	1x13W TC-TEL / GX24q-1	Grey	

				 OSRAM: HCI-T PHILIPS: CDM-T	LEO 160 Beam 4° (WALL LIGHTING)
					<ul style="list-style-type: none"> Die-cast aluminium body. Refractive clear glass
PRICE LIST					
CODE	DESCRIPTION			COLOUR	
850701	LEO 160 - 3511E	beam 4°	1x35W HIT-CE / G12	White	
850703	LEO 160 - 3516E	beam 4°	1x35W HIT-CE / G12	Anthracite	
850702	LEO 160 - 3517E	beam 4°	1x35W HIT-CE / G12	Grey	

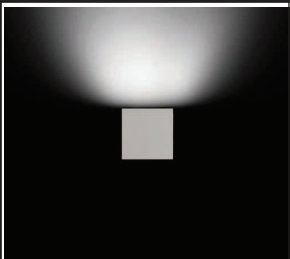
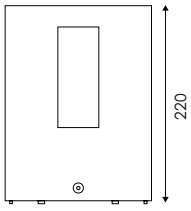
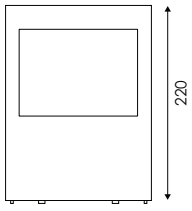
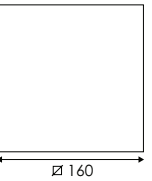
				 OSRAM: HCI-T PHILIPS: CDM-T	LEO 160 Beam 35° (WALL LIGHTING)
					<ul style="list-style-type: none"> Die-cast aluminium body. Refractive clear glass
PRICE LIST					
CODE	DESCRIPTION			COLOUR	
850711	LEO 160 - 3511B	beam 35°	1x35W HIT-CE / G12	White	
850713	LEO 160 - 3516B	beam 35°	1x35W HIT-CE / G12	Anthracite	
850712	LEO 160 - 3517B	beam 35°	1x35W HIT-CE / G12	Grey	

				 OSRAM: HCI-T PHILIPS: CDM-T	LEO 160 Beam 75° (WALL LIGHTING)
					<ul style="list-style-type: none"> Die-cast aluminium body. Refractive clear glass
PRICE LIST					
CODE	DESCRIPTION			COLOUR	
850721	LEO 160 - 3511F	beam 75°	1x35W HIT-CE / G12	White	
850723	LEO 160 - 3516F	beam 75°	1x35W HIT-CE / G12	Anthracite	
850722	LEO 160 - 3517F	beam 75°	1x35W HIT-CE / G12	Grey	



To ensure the degree of protection use only suitable flexible cables like the class H07RN-F or similar.

HIT-CE
G12 OSRAM: HCI-T
PHILIPS: CDM-T

LEO 160
Beam 4° / 4°
(WALL LIGHTING)

• Die-cast aluminium body.
• Refractive clear glass

CODE	DESCRIPTION	COLOUR
850731	LEO 160 - 3521E beam 4° / 4° 1x35W HIT-CE / G12	White
850733	LEO 160 - 3526E beam 4° / 4° 1x35W HIT-CE / G12	Anthracite
850732	LEO 160 - 3527E beam 4° / 4° 1x35W HIT-CE / G12	Grey

HIT-CE
G12 OSRAM: HCI-T
PHILIPS: CDM-T

LEO 160
Beam 35° / 35°
(WALL LIGHTING)

• Die-cast aluminium body.
• Refractive clear glass

CODE	DESCRIPTION	COLOUR
850741	LEO 160 - 3521B beam 35° / 35° 1x35W HIT-CE / G12	White
850743	LEO 160 - 3526B beam 35° / 35° 1x35W HIT-CE / G12	Anthracite
850742	LEO 160 - 3527B beam 35° / 35° 1x35W HIT-CE / G12	Grey

HIT-CE
G12 OSRAM: HCI-T
PHILIPS: CDM-T

LEO 160
Beam 4° / 75°
(WALL LIGHTING)

• Die-cast aluminium body.
• Refractive clear glass

CODE	DESCRIPTION	COLOUR
850751	LEO 160 - 3501EF beam 4° / 75° 1x35W HIT-CE / G12	White
850753	LEO 160 - 3506EF beam 4° / 75° 1x35W HIT-CE / G12	Anthracite
850752	LEO 160 - 3507EF beam 4° / 75° 1x35W HIT-CE / G12	Grey

HIT-CE
G12 OSRAM: HCI-T
PHILIPS: CDM-T



LEO 160
Beam 75° / 75°
(WALL LIGHTING)



• Die-cast aluminium body.
• Refractive clear glass

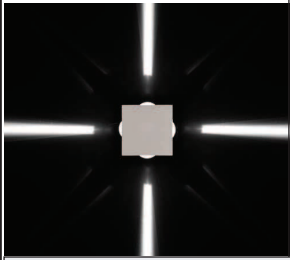
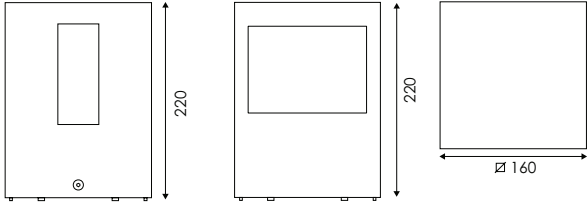

CODE	DESCRIPTION	COLOUR
850761	LEO 160 - 3521F beam 75° / 75° 1x35W HIT-CE / G12	White
850763	LEO 160 - 3526F beam 75° / 75° 1x35W HIT-CE / G12	Anthracite
850762	LEO 160 - 3527F beam 75° / 75° 1x35W HIT-CE / G12	Grey

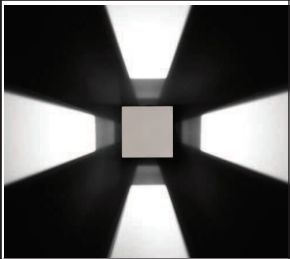
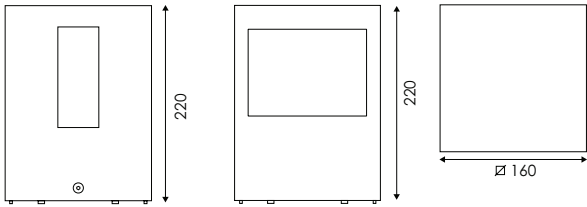

To ensure the degree of protection use only suitable flexible cables like the class H07RN-F or similar.

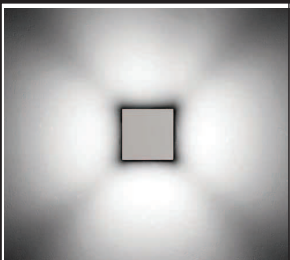
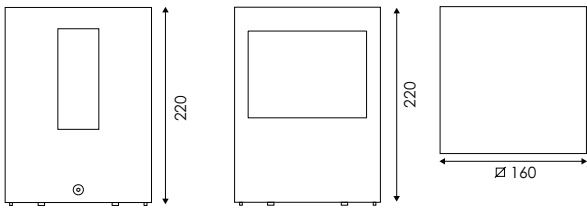

		 OSRAM: HCI-T PHILIPS: CDM-T	LEO 160 Beam 4° (WALL LIGHTING)
			<ul style="list-style-type: none"> • Die-cast aluminium body. • Refractive clear glass
PRICE LIST			
CODE	DESCRIPTION	COLOUR	
850771	LEO 160 - 3541E beam 4° 1x35W HIT-CE / G12	White	
850773	LEO 160 - 3546E beam 4° 1x35W HIT-CE / G12	Anthracite	
850772	LEO 160 - 3547E beam 4° 1x35W HIT-CE / G12	Grey	



		 OSRAM: HCI-T PHILIPS: CDM-T	LEO 160 Beam 35° (WALL LIGHTING)
			<ul style="list-style-type: none"> • Die-cast aluminium body. • Refractive clear glass
PRICE LIST			
CODE	DESCRIPTION	COLOUR	
850781	LEO 160 - 3541B beam 35° 1x35W HIT-CE / G12	White	
850783	LEO 160 - 3546B beam 35° 1x35W HIT-CE / G12	Anthracite	
850782	LEO 160 - 3547B beam 35° 1x35W HIT-CE / G12	Grey	

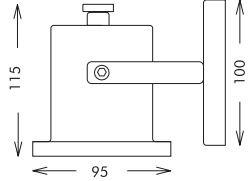

		 OSRAM: HCI-T PHILIPS: CDM-T	LEO 160 Beam 75° (WALL LIGHTING)
			<ul style="list-style-type: none"> • Die-cast aluminium body. • Refractive clear glass
PRICE LIST			
CODE	DESCRIPTION	COLOUR	
850791	LEO 160 - 3541F beam 75° 1x35W HIT-CE / G12	White	
850793	LEO 160 - 3546F beam 75° 1x35W HIT-CE / G12	Anthracite	
850792	LEO 160 - 3547F beam 75° 1x35W HIT-CE / G12	Grey	



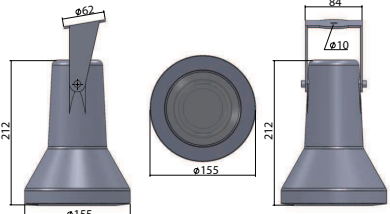

To ensure the degree of protection use only suitable flexible cables like the class H07RN-F or similar.

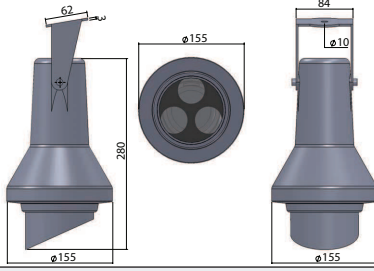
		 PAR 16 <ul style="list-style-type: none"> Stainless steel body and base, inox AISI 316. Tempered transparent protection glass 	SCUBA SPOT						
									
<table border="1"> <thead> <tr> <th>CODE</th> <th>DESCRIPTION</th> <th>COLOUR</th> </tr> </thead> <tbody> <tr> <td>852625</td> <td>SCUBA SPOT 281050 1x max. 35W PAR 16 / GU10</td> <td>Inox</td> </tr> </tbody> </table>			CODE	DESCRIPTION	COLOUR	852625	SCUBA SPOT 281050 1x max. 35W PAR 16 / GU10	Inox	PRICE LIST
CODE	DESCRIPTION	COLOUR							
852625	SCUBA SPOT 281050 1x max. 35W PAR 16 / GU10	Inox							

		LED CHIP - High Brightness <ul style="list-style-type: none"> Aluminium body Beam distribution reflector Glass thickness 5mm Supplied with 3x1 NEOPRENE 1,5m. 	FOCUS - LED										
													
<table border="1"> <thead> <tr> <th>CODE</th> <th>DESCRIPTION</th> <th>LED COLOUR</th> <th>BEAMS</th> <th>BODY COLOUR</th> </tr> </thead> <tbody> <tr> <td>84727</td> <td>FOCUS LED 50W</td> <td>Selection from table A</td> <td>Selection from table B1</td> <td>Selection from table C</td> </tr> </tbody> </table>			CODE	DESCRIPTION	LED COLOUR	BEAMS	BODY COLOUR	84727	FOCUS LED 50W	Selection from table A	Selection from table B1	Selection from table C	PRICE LIST
CODE	DESCRIPTION	LED COLOUR	BEAMS	BODY COLOUR									
84727	FOCUS LED 50W	Selection from table A	Selection from table B1	Selection from table C									

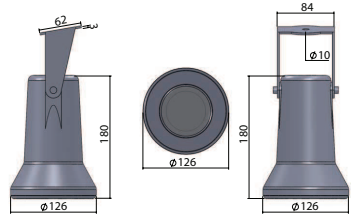
		LED CHIP - High Brightness <ul style="list-style-type: none"> Aluminium body Beam distribution reflector Glass thickness 5mm Supplied with 3x1 NEOPRENE 1,5m. 	FOCUS - LED with anti-glare louvre										
													
<table border="1"> <thead> <tr> <th>CODE</th> <th>DESCRIPTION</th> <th>LED COLOUR</th> <th>BEAMS</th> <th>BODY COLOUR</th> </tr> </thead> <tbody> <tr> <td>84747</td> <td>FOCUS LED 50W (with anti-glare louvre)</td> <td>Selection from table A</td> <td>Selection from table B1</td> <td>Selection from table C</td> </tr> </tbody> </table>			CODE	DESCRIPTION	LED COLOUR	BEAMS	BODY COLOUR	84747	FOCUS LED 50W (with anti-glare louvre)	Selection from table A	Selection from table B1	Selection from table C	PRICE LIST
CODE	DESCRIPTION	LED COLOUR	BEAMS	BODY COLOUR									
84747	FOCUS LED 50W (with anti-glare louvre)	Selection from table A	Selection from table B1	Selection from table C									

		LED CHIP - High Brightness <ul style="list-style-type: none"> Aluminium body Beam distribution reflector Glass thickness 5mm Supplied with 3x1 NEOPRENE 1,5m. 	FOCUS Mini - LED										
													
<table border="1"> <thead> <tr> <th>CODE</th> <th>DESCRIPTION</th> <th>LED COLOUR</th> <th>BEAMS</th> <th>BODY COLOUR</th> </tr> </thead> <tbody> <tr> <td>84712</td> <td>FOCUS MINI LED 18W</td> <td>Selection from table A</td> <td>Selection from table B2</td> <td>Selection from table C</td> </tr> </tbody> </table>			CODE	DESCRIPTION	LED COLOUR	BEAMS	BODY COLOUR	84712	FOCUS MINI LED 18W	Selection from table A	Selection from table B2	Selection from table C	PRICE LIST
CODE	DESCRIPTION	LED COLOUR	BEAMS	BODY COLOUR									
84712	FOCUS MINI LED 18W	Selection from table A	Selection from table B2	Selection from table C									

LED COLOUR:

A 1 Cold 2 Warm 3 Neutral

BEAMS:

B1 02 wide 03 super-wide

B2 01 narrow 03 wide

Colour Codes:

C 0 Colours 1 White 2 Titan 3 Black 4 Chrome 5 matt Alum.





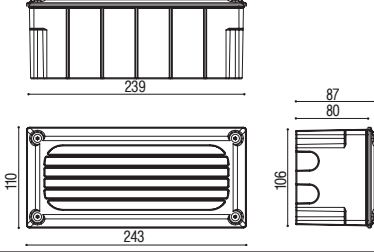





 OSRAM: DULUX EL
PHILIPS: PL-ELECTRONIC

 OSRAM: DULUX D
PHILIPS: PL-C

 OSRAM: DULUX S
PHILIPS: PL-S

INTRA C
(RECESSED LUMINAIRES)

  

PRICE LIST

CODE	DESCRIPTION	COLOUR	
85351	1005.101B / M / N 1x 8W TC-DSE / E14	White, Grey, Black	
85352	1005.107B / M / N 1x 9W TC-S / G23	White, Grey, Black	with Conventional Ballast & Capacitor
85353	1005.110B / M / N 1x18W TC-D / G24d-2	White, Grey, Black	with Conventional Ballast & Capacitor



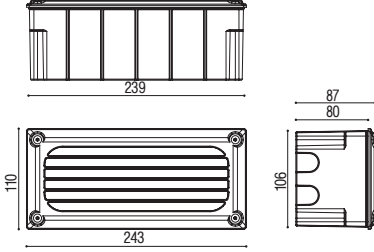



 OSRAM: DULUX EL
PHILIPS: PL-ELECTRONIC

 OSRAM: DULUX D
PHILIPS: PL-C

 OSRAM: DULUX S
PHILIPS: PL-S

INTRA GA [open blind]
(RECESSED LUMINAIRES)

  

PRICE LIST

CODE	DESCRIPTION	COLOUR	
85354	1006.101B / M / N 1x 8W TC-DSE / E14	White, Grey, Black	
85355	1006.107B / M / N 1x 9W TC-S / G23	White, Grey, Black	with Conventional Ballast & Capacitor
85356	1006.110B / M / N 1x18W TC-D / G24d-2	White, Grey, Black	with Conventional Ballast & Capacitor

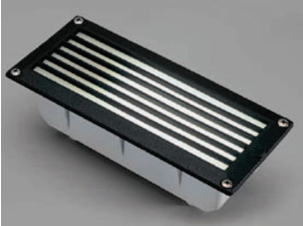

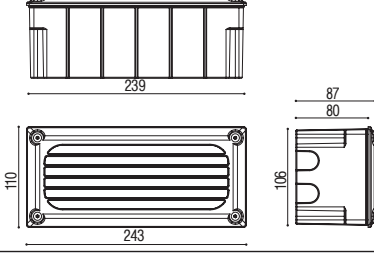



 OSRAM: DULUX EL
PHILIPS: PL-ELECTRONIC

 OSRAM: DULUX D
PHILIPS: PL-C

 OSRAM: DULUX S
PHILIPS: PL-S

INTRA GC [closed blind]
(RECESSED LUMINAIRES)

PRICE LIST

CODE	DESCRIPTION	COLOUR	
85357	1007.101B / M / N 1x 8W TC-DSE / E14	White, Grey, Black	
85358	1007.107B / M / N 1x9 W TC-S / G23	White, Grey, Black	with Conventional Ballast & Capacitor
85359	1007.110B / M / N 1x18W TC-D / G24d-2	White, Grey, Black	with Conventional Ballast & Capacitor



Colour Codes:

- 1 White
 2 Titan
 3 Black
 4 Chrome
 5 matt Alum.
 6 Gold
 7 matt Gold
 8 Bronze
 9 Anodized

		<p>Outercasing 968</p> <p>103x103x70mm</p>	<p>QT-LP 9 G4</p> <p>OSRAM: HALOSTAR PHILIPS: CAPSULELINE</p>	<p>TYCO (RECESSED LUMINAIRES)</p>							
					<ul style="list-style-type: none"> Aluminium body. Sandblasted glass. 	<p>CE IP 54</p>					
CODE			DESCRIPTION			COLOUR			PRICE LIST		
85702	2666 + 968	1x20W QT-LP 9 / G4	White, Titan			Without Transformer			+ Transformer Selection 12V		
857025	2666 + 968	1x20W QT-LP 9 / G4	matt Alum.						+ Transformer Selection 12V		

<p>with Metal Blind</p>		<p>Outercasing 967</p> <p>Ø97x 70mm</p>	<p>QT-LP 9 G4</p> <p>OSRAM: HALOSTAR PHILIPS: CAPSULELINE</p>	<p>TYCO (RECESSED LUMINAIRES)</p>							
					<ul style="list-style-type: none"> Aluminium body. Metal blind. 	<p>CE IP 54</p>					
CODE			DESCRIPTION			COLOUR			PRICE LIST		
85701	2664 + 967	1x20W QT-LP 9 / G4	White, Titan			Without Transformer			+ Transformer Selection 12V		
857015	2664 + 967	1x20W QT-LP 9 / G4	matt Alum.						+ Transformer Selection 12V		

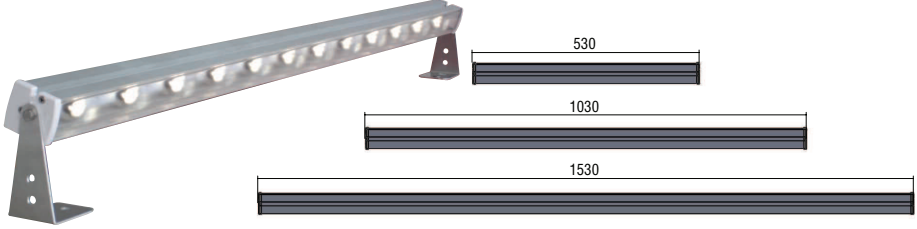

					<p>LED CHIP - High Brightness</p> <ul style="list-style-type: none"> • Aluminium body. • Beam distribution lens • Transparent plastic profile cover. • Silicone insulation. • Supplied with 3x1 NEOPRENE 1,5m. 	<p>SLIM 3 - LED</p> 
CODE	DESCRIPTION	LED COLOUR	BEAM	BODY COLOUR	DRIVERS	
812111	SLIM 3 LED 0,53m 21W (9-21W) Adjustable	Selection from table A	Selection from table B	Selection from table C	1 driver required	
812221	SLIM 3 LED 1,03m 39W (14-39W) Adjustable	Selection from table A	Selection from table B	Selection from table C	1 driver required	
812331	SLIM 3 LED 1,53m 65W (20-65W) Adjustable	Selection from table A	Selection from table B	Selection from table C	2 drivers required	

Led Colour:
A 1 Cold 2 Warm 3 Neutral



Beams Codes:
B 1 spot 2 medium 3 wide 4 ww

Colour Codes:
C 0 Colours 4 Anodized

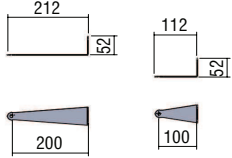
			<p>SLIM 3 - LED ACCESSORIES</p>
CODE		DESCRIPTION	PRICE LIST
800041	DRIVER max. 50W		
801101	Set aluminium brackets 10cm		
801102	Set aluminium brackets 20cm		

L = Μήκος

14W = 650mm
21W = 950mm
28/54W = 1250mm
35/49W = 1550mm

30mm

55mm

OSRAM: T5
PHILIPS: TL5

TUBE
(WALL LIGHTING)

CE

F

⏚

IP 67

- Clear and frosted tube in polycarbonate
- Removable socket and gear frame
- End caps with cable-gland or blind plugs in PMMA

				PRICE LIST
CODE	DESCRIPTION	COLOUR	with Electronic Control Gear	
850600	TUBE TRANSPARENT 1x14W T16 LR-1400			
850610	TUBE TRANSPARENT 1x21W T16 LR-2100			
850620	TUBE TRANSPARENT 1x28W T16 LR-2800			
850630	TUBE TRANSPARENT 1x35W T16 LR-3500			
850640	TUBE FROSTED 1x14W T16 LRO-1400			
850650	TUBE FROSTED 1x21W T16 LRO-2100			
850660	TUBE FROSTED 1x28W T16 LRO-2800			
850670	TUBE FROSTED 1x35W T16 LRO-3500			

Set for surface mounted installation

Set for pendant installation

Specular parabolic reflector from anodized aluminium

TUBE - ACCESSORIES
(WALL LIGHTING)

				PRICE LIST
CODE	DESCRIPTION	COLOUR		
805112	Set for surface mounted installation (set 2 pieces) Z-LR1	Grey		
805113	Set for pendant installation (set 2 pieces) Z-LR2	Grey		
805114	Reflector for 14W Z-LRSR14			
805115	Reflector for 21W Z-LRSR21			
805116	Reflector for 28/54W Z-LRSR28			
805117	Reflector for 35/49W Z-LRSR35			

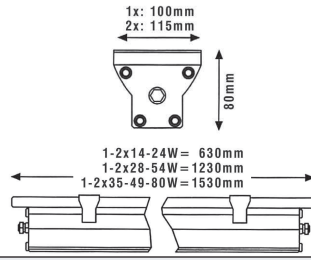

OSRAM: T5
PHILIPS: TL5

SLIM 5
(WALL LIGHTING)

- Die-cast aluminium body
- Tempered glass
- Hooks and brackets in stainless steel
- High purity aluminium reflector



PRICE LIST

with Electronic Control Gear

CODE	DESCRIPTION	COLOUR
852635	SLIM 5 1x14W T16 94114	matt Alum.
852645	SLIM 5 2x14W T16 94214	matt Alum.
852655	SLIM 5 1x24W T16 94124	matt Alum.
852665	SLIM 5 2x24W T16 94224	matt Alum.
852675	SLIM 5 1x28W T16 94128	matt Alum.
852685	SLIM 5 2x28W T16 94228	matt Alum.
852735	SLIM 5 1x54W T16 94154	matt Alum.
852745	SLIM 5 2x54W T16 94254	matt Alum.
852695	SLIM 5 1x35W T16 94135	matt Alum.
852705	SLIM 5 2x35W T16 94235	matt Alum.
852715	SLIM 5 1x49W T16 94149	matt Alum.
852725	SLIM 5 2x49W T16 94249	matt Alum.
852755	SLIM 5 1x80W T16 94180	matt Alum.
852765	SLIM 5 2x80W T16 94280	matt Alum.

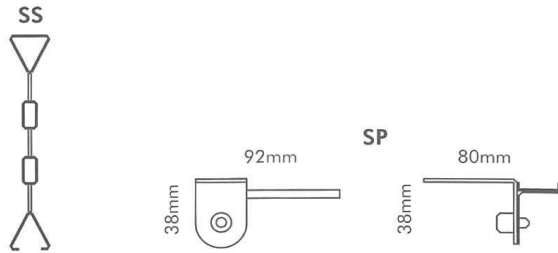

SLIM 5 - ACCESSORIES
(WALL LIGHTING)

PRICE LIST

CODE	DESCRIPTION	COLOUR
805501	Suspension kit for 1-lamp luminaire SS 1x... (2 pieces set)	Inox
805502	Suspension kit for 2-lamp luminaire SS 2x... (2 pieces set)	Inox
805503	Bracket arm for wall mounting from stainless steel for 1-lamp luminaire SP 1x...	Inox
805504	Bracket arm for wall mounting from stainless steel for 2-lamp luminaire SP 2x...	Inox