

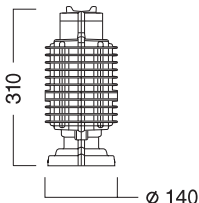





HIGH BAY





	+ Accessories COPA D IP20 (Body)	Page 270		SECUR (Body)	Page 276		+ Accessories REFLECTOR YES C	Page 280
	+ Accessories COPA D IP54 (Body)	Page 270		REFLECTORS SECUR	Page 276		YES SHOW (Body)	Page 281
	+ Accessories REFLECTOR RKID	Page 270		CUPOLA (Body)	Page 277		REFL. YES SHOW TECH	Page 281
	+ Accessories REFLECTOR RAP	Page 271		REFLECTORS CUPOLA	Page 277		REFL. YES SHOW RIG	Page 281
	+ Accessories REFLECTOR RKID PRISM	Page 271		CABANA 79 (Body)	Page 278		REFL. YES SHOW C	Page 282
	+ Accessories COPA I IP20 (Body)	Page 272		REFL. CABANA 791 & 792	Page 278			
	+ Accessories COPA I IP65 (Body)	Page 272		REFL. CABANA 791x250	Page 278			
	+ Accessories REFLECTOR RAB	Page 273		YES (Body)	Page 279			
	+ Accessories REFLECTOR RAT	Page 273		+ Accessories REFLECTOR YES PRISMATIC	Page 279			
	+ Accessories REFLECTOR RAN	Page 273		+ Accessories REFLECTOR YES TECH	Page 280			
	+ Accessories REFLECTOR RKID PRISM	Page 273		+ Accessories REFLECTOR YES RIG	Page 280			





 OSRAM: DULUX T / E PHILIPS: PL-T / 4P	 OSRAM: HALOLUX PHILIPS: HALOGEN A	 OSRAM: HQI-E, HCI-E PHILIPS: CDM-ET
 OSRAM: HCI-T PHILIPS: CDM-T	 OSRAM: - PHILIPS: SDW-T	

COPA D IP20 (Body)







• Die-cast aluminium, untreated with fine texture.

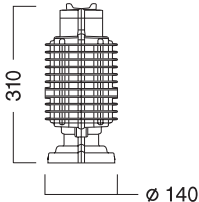



PRICE LIST							
DESCRIPTION	Without Control Gear		Conventional Ballast and capacitor		Electronic Ballast		
	CODE	PRICE	CODE	PRICE	CODE	PRICE	
COPA D 1x 32W TC-TEL / GX24q-3					871121		+ Reflector Selection
COPA D 1x 42W TC-TEL / GX24q-4					871221		+ Reflector Selection
COPA D 1x 57W TC-TEL / GX24q-5					871321		+ Reflector Selection
COPA D 1x max.250W QT32 / E27	871491						+ Reflector Selection
COPA D 1x 70W HIE / E27			871511				+ Reflector Selection
COPA D 1x150W HIE / E27			871611				+ Reflector Selection
COPA D 1x 70W HIT-CE / G12			871711				+ Reflector Selection
COPA D 1x150W HIT-CE / G12			871811				+ Reflector Selection
COPA D 1x100W HST / PG12-1			871911				+ Reflector Selection





 OSRAM: HCI-T PHILIPS: CDM-T	 OSRAM: - PHILIPS: SDW-T
--	--

COPA D IP54 (Body)

• Die-cast aluminium, untreated with fine texture.



PRICE LIST				
CODE	DESCRIPTION	COLOUR	Conventional Control Gear & Capacitor	
871712	COPA D IP54 1x 70W HIT-CE / G12			+ Reflector Selection
871812	COPA D IP54 1x150W HIT-CE / G12			+ Reflector Selection
871912	COPA D IP54 1x100W HST / PG12-1			+ Reflector Selection

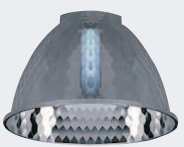

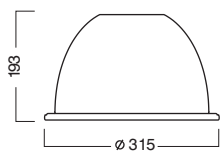







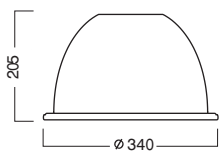

Plastic specular reflector optic made of polycarbonate with faceted structure, semi-translucent aluminized for TC-TEL compact lamps.

REFLECTOR RKID FOR COPA D (IP20)



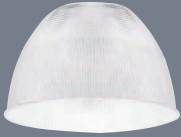
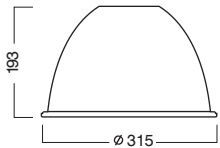







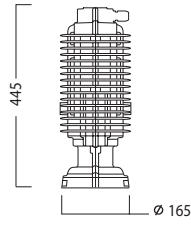









PRICE LIST			
CODE	DESCRIPTION	COLOUR	
807110	COPA D RKID 20968040		

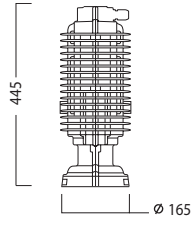

		<p>REFLECTOR RAP FOR COPA D (IP20 / IP54)</p> <p>Reflector optic made of pure aluminium with faceted structure, anodized in a highly specular finish, optimized for point-shaped lamps (QT32, HIE, HIT-CE, HST).</p> <p>  </p>
PRICE LIST		
CODE	DESCRIPTION	COLOUR
807105	COPA D RAP 20969367	



		<p>REFLECTOR RKID PRISM FOR COPA D (IP20)</p> <p>Prismatic reflector made of PMMA for direct/indirect light distribution. (TC-TEL, QT32, HIE, HIT-CE, HST)</p> <p>Note: Not permitted for 150W HIT version. (HIT only with PC reflector and cover panel).</p> <p>  </p>
PRICE LIST		
CODE	DESCRIPTION	COLOUR
807101	COPA D PRISMATIC Ø315	



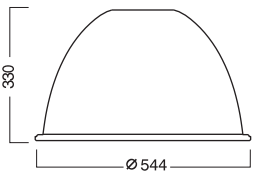

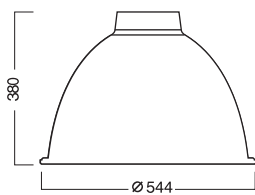

		 <p>445 ∅ 165</p>		 OSRAM: HQL PHILIPS: HPL	 OSRAM: NAV-E PHILIPS: SON	 OSRAM: HQI-E/NSI PHILIPS: HPI PLUS BU	COPA I IP20 (Body)
<p>• Die-cast aluminium, untreated with fine texture.</p>							   
				PRICE LIST			
CODE	DESCRIPTION	COLOUR	Conventional Control Gear & Capacitor				
	For high pressure mercury vapour lamp						
872211	COPA I 250 1x250W HME / E40					+ Reflector Selection	
872311	COPA I 400 1x400W HME / E40					+ Reflector Selection	
	For high pressure sodium lamp						
872411	COPA I 251 1x250W HSE / E40					+ Reflector Selection	
872511	COPA I 401 1x400W HSE / E40					+ Reflector Selection	
	For metal halide lamp OSRAM HQI-E/NSI, PHILIPS HPI PLUS BU, SYLVANIA HSI-HX						
872811	COPA I 250P 1x250W HIE / E40					+ Reflector Selection	
872911	COPA I 400P 1x400W HIE / E40					+ Reflector Selection	



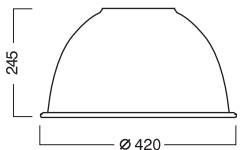

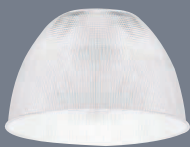
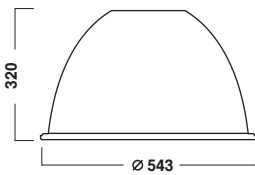

		 <p>445 ∅ 165</p>		 OSRAM: HQL PHILIPS: HPL	 OSRAM: NAV-E PHILIPS: SON	 OSRAM: HQI-E/NSI PHILIPS: HPI PLUS BU	COPA I IP65 (Body)
<p>• Die-cast aluminium, untreated with fine texture.</p>							   
				PRICE LIST			
CODE	DESCRIPTION	COLOUR	Conventional Control Gear & Capacitor				
	For high pressure mercury vapour lamp						
872212	COPA I 250 IP65 1x250W HME / E40					+ Reflector Selection	
872312	COPA I 400 IP65 1x400W HME / E40					+ Reflector Selection	
	For high pressure sodium lamp						
872412	COPA I 251 IP65 1x250W HSE / E40					+ Reflector Selection	
872512	COPA I 401 IP65 1x400W HSE / E40					+ Reflector Selection	
	For metal halide lamp OSRAM HQI-E/NSI, PHILIPS HPI PLUS BU, SYLVANIA HSI-HX						
872812	COPA I 250P IP65 1x250W HIE / E40					+ Reflector Selection	
872912	COPA I 400P IP65 1x400W HIE / E40					+ Reflector Selection	

		<p>Specular reflector made of pure aluminium with integral faceted structure, anodized in a highly specular finish. Reflector for 250/400W wide-angle, 250W narrow-beam if lampholder is adjusted on site.</p>	<p>REFLECTOR RAB FOR COPA I (IP20 / IP65)</p> 
			PRICE LIST
CODE	DESCRIPTION	COLOUR	
807103	COPA I RAB 20969348		

		<p>Specular reflector made of pure aluminium with integral faceted structure, anodized in a highly specular finish for 400W narrow beam.</p>	<p>REFLECTOR RAT FOR COPA I (IP20 / IP65)</p> 
			PRICE LIST
CODE	DESCRIPTION	COLOUR	
807106	COPA I RAT 20969354		

		<p>Specular reflector made of pure aluminium with smooth surface. Anodized in a highly specular finish. Reflector for 250/400W wide-angle, 250W narrow-beam if lampholder is adjusted on site.</p> <p>Note: cover glass not possible</p>	<p>REFLECTOR RAN FOR COPA I (IP20)</p> 
			PRICE LIST
CODE	DESCRIPTION	COLOUR	
807104	COPA I RAN 20969423		

		<p>Prismatic reflector made of PMMA for direct/indirect light distribution, for 250W or 400W.</p>	<p>REFLECTOR RKID PRISM FOR COPA I (IP20)</p> 
			PRICE LIST
CODE	DESCRIPTION	COLOUR	
807102	COPA I PRISMATIC Ø543		

				COPA - ACCESSORIES ZAD	
		Ceiling bracket			
CODE	DESCRIPTION	COLOUR	PRICE LIST		
ZS 20350658	ZAD 20350658				
				COPA - ACCESSORIES ZAR	
		Chain suspension bracket.			
CODE	DESCRIPTION	COLOUR	PRICE LIST		
ZS 20969635	ZAR 20969635				
				COPA - ACCESSORIES ZAKK	
		Chain suspension / m.			
CODE	DESCRIPTION	COLOUR	PRICE LIST		
605105	ZAKK				
				COPA - ACCESSORIES ASI	
		Cord suspension.			
CODE	DESCRIPTION	LENGTH	PRICE LIST		
ZS 20350588	ASI 1000 O-L 20350588	1000mm			
ZS 20350605	ASI 2000 O-L 20350605	2000mm			
ZS 20936702	ASI 4000 O-L 20936702	4000mm			
				COPA - ACCESSORIES API	
		Pendant suspension.			
CODE	DESCRIPTION	LENGTH	COLOUR	PRICE LIST	
ZS 20934969	API 500 E-L 20934969	500mm	Silver		
ZS 20934975	API 1000 E-L 20934975	1000mm	Silver		
ZS 20934981	API 1500 E-L 20934981	1500mm	Silver		
ZS 20934997	API 2000 E-L 20934997	2000mm	Silver		
				COPA - ACCESSORIES PRO-BALDACHIN	
		Feed-in ceiling rose.			
CODE	DESCRIPTION	COLOUR	PRICE LIST		
ZS 20668728	PRO-BALDACHIN 20668728				

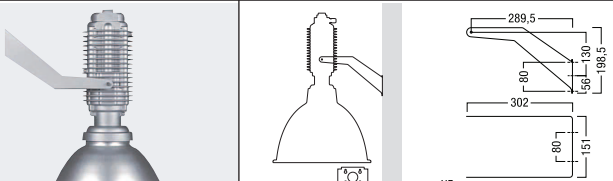
		<p>Wall bracket.</p>	<p>COPA - ACCESSORIES D-WA & I-WA</p>	
CODE	DESCRIPTION	COLOUR	PRICE LIST	
ZS 20968196	D-WA 20968196 wall bracket for COPA D			
ZS 20968180	I-WA 20968180 wall bracket for COPA I			

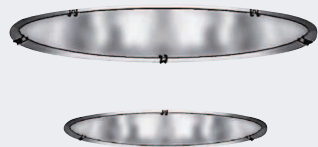
		<p>Recommended use of glass when it comes to high pressure lamps, e.g. metal halide lamps</p> <p>Safety glass.</p>	<p>COPA - ACCESSORIES D AG & I AG</p>	
CODE	DESCRIPTION	COLOUR	PRICE LIST	
ZS 20969445	COPA D AG 300 20969445 safety glass COPA D			
ZS 20969439	COPA I AG 500 20969439 safety glass COPA I			

		<p>Plastic diffuser made of PMMA for COPA D.</p> <p>Note: may only be used with TC-TELI 32/42/57W</p>	<p>COPA - ACCESSORIES D ABD & I ABD</p>	
CODE	DESCRIPTION	COLOUR	PRICE LIST	
ZS 22157544	D ABD 312 22157544			





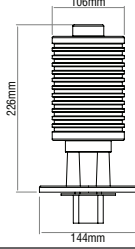

TC-TEL OSRAM: DULUX T / E
PHILIPS: PL-T / 4P

HIT-CE OSRAM: HCI-T
PHILIPS: CDM-T

HST OSRAM: -
G12 PHILIPS: SDW-TG

SECUR (Body)



- Die-cast aluminium alloy body.
- Inner reflector (for lamps HIT-CE, HST), made of pure aluminium with faceted structure (SPf 12°, FLf 24°, WFLf 44°, VWFLf 60°).

				PRICE LIST	
CODE	DESCRIPTION	COLOUR	Electronic Control Gear		
874012	12742005 SECUR 812 2x42W TC-TEL / GX24q-4	Titan		+ Reflector Selection	
874022	12760105 SECUR 812 SPf 1x70W HIT-CE / G12	Titan		+ Reflector Selection	
874032	12760205 SECUR 812 FLf 1x70W HIT-CE / G12	Titan		+ Reflector Selection	
874042	12760305 SECUR 812 WFLf 1x70W HIT-CE / G12	Titan		+ Reflector Selection	
874052	12760405 SECUR 812 VWFLf 1x70W HIT-CE / G12	Titan		+ Reflector Selection	
874062	12766105 SECUR 816 SPf 1x70W HIT-CE / G12	Titan		+ Reflector Selection	
874072	12766205 SECUR 816 FLf 1x70W HIT-CE / G12	Titan		+ Reflector Selection	
874082	12766305 SECUR 816 WFLf 1x70W HIT-CE / G12	Titan		+ Reflector Selection	
874092	12766405 SECUR 816 VWFLf 1x70W HIT-CE / G12	Titan		+ Reflector Selection	
874102	12770105 SECUR 812 SPf 1x150W HIT-CE / G12	Titan		+ Reflector Selection	
874112	12770205 SECUR 812 FLf 1x150W HIT-CE / G12	Titan		+ Reflector Selection	
874122	12770305 SECUR 812 WFLf 1x150W HIT-CE / G12	Titan		+ Reflector Selection	
874132	12770405 SECUR 812 VWFLf 1x150W HIT-CE / G12	Titan		+ Reflector Selection	
874142	12775105 SECUR 816 SPf 1x150W HIT-CE / G12	Titan		+ Reflector Selection	
874152	12775205 SECUR 816 FLf 1x150W HIT-CE / G12	Titan		+ Reflector Selection	
874162	12775305 SECUR 816 WFLf 1x150W HIT-CE / G12	Titan		+ Reflector Selection	
874172	12775405 SECUR 816 VWFLf 1x150W HIT-CE / G12	Titan		+ Reflector Selection	
874182	12790105 SECUR 812 SPf 1x100W HST / GX12-1	Titan		+ Reflector Selection	
874192	12790205 SECUR 812 FLf 1x100W HST / GX12-1	Titan		+ Reflector Selection	
874202	12790305 SECUR 812 WFLf 1x100W HST / GX12-1	Titan		+ Reflector Selection	
874212	12790405 SECUR 812 VWFLf 1x100W HST / GX12-1	Titan		+ Reflector Selection	
874222	12796105 SECUR 816 SPf 1x100W HST / GX12-1	Titan		+ Reflector Selection	
874232	12796205 SECUR 816 FLf 1x100W HST / GX12-1	Titan		+ Reflector Selection	
874242	12796305 SECUR 816 WFLf 1x100W HST / GX12-1	Titan		+ Reflector Selection	
874252	12796405 SECUR 816 VWFLf 1x100W HST / GX12-1	Titan		+ Reflector Selection	



- Prismatic reflector made of PMMA for direct/indirect light distribution.
- Aluminium reflector in blue, red, yellow and silver colour.

REFLECTORS SECUR



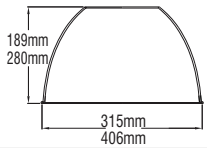

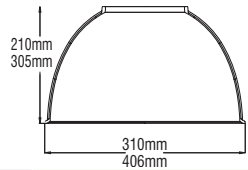

				PRICE LIST	
CODE	DESCRIPTION	COLOUR	Electronic Control Gear		
807301	PRISMATIC Ø315 812 PRISMATIC	Prismatic			
807402	19834422 812 ALUMINIUM BLUE	Blue			
807405	19834423 812 ALUMINIUM RED	Red			
807403	19834424 812 ALUMINIUM YELLOW	Yellow			
807404	19834425 812 ALUMINIUM SILVER	Silver			
807302	PRISMATIC Ø406 816 PRISMATIC	Prismatic			
807406	19834432 816 ALUMINIUM BLUE	Blue			
807408	19834433 816 ALUMINIUM RED	Red			
807407	19834434 816 ALUMINIUM YELLOW	Yellow			
807409	19834435 816 ALUMINIUM SILVER	Silver			



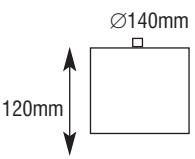

CUPOLA PICCOLA

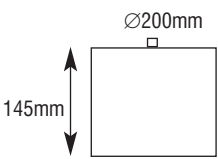

CUPOLA GRANDE



 OSRAM: HALOLUX
 PHILIPS: HALOGEN A

 OSRAM: HCI-T
 PHILIPS: CDM-T

CUPOLA (Body)



• Aluminium body.

PRICE LIST								
DESCRIPTION	COLOUR	Without Control Gear		Conventional Ballast and capacitor		Electronic Control Gear		
		CODE	PRICE	CODE	PRICE	CODE	PRICE	
CUPOLA PICCOLA 1x max.100W QT32 / E27	Titan	873012						+ Reflector Selection
CUPOLA PICCOLA 1x 35W HIT-CE / G12	Titan					873022		+ Reflector Selection
CUPOLA GRANDE 1x max.250W QT32 / E27	Titan	873032						+ Reflector Selection
CUPOLA GRANDE 1x 70W HIT-CE / G12	Titan			873042				+ Reflector Selection
CUPOLA GRANDE 1x150W HIT-CE / G12	Titan			873052				+ Reflector Selection



• Prismatic reflector made of PMMA for direct/indirect light distribution.











• Anodized aluminium reflector.







REFLECTORS CUPOLA





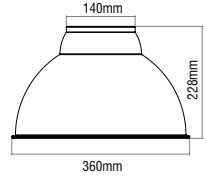

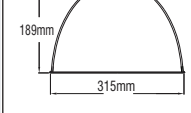



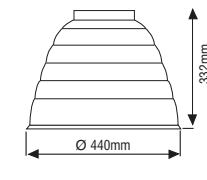

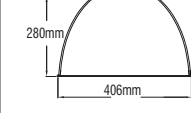

PRICE LIST			
CODE	DESCRIPTION	COLOUR	
807301	PRISMATIC Ø315 (for CUPOLA PICCOLA)	Prismatic	
807404	ALUMINIUM Ø310 (for CUPOLA PICCOLA)	Aluminium	
807302	PRISMATIC Ø406 (for CUPOLA GRANDE)	Prismatic	
807409	ALUMINIUM Ø406 (for CUPOLA GRANDE)	Aluminium	

791x160W  87mm 104mm 158mm	791x250W or 792x26W  80mm 130mm 188mm	 OSRAM: HALOLUX PHILIPS: HALOGEN A  OSRAM: DULUX D PHILIPS: PL-C	CABANA 79 (Body)
• Aluminium body.			 

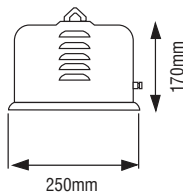

DESCRIPTION		COLOUR	Without Control Gear		Conventional ballast & capacitor		
			CODE	PRICE	CODE	PRICE	
791x160	1x max. 100W QT32 / E27	White, Titan, Colours	11419				+ Reflector Selection
791x160	1x max. 100W QT32 / E27 for ALUM. REFL. Ø360mm or REFL. PLACTIC PRISMATIC Ø315	Anodized	114199				+ Reflector Selection
791x250	1x max. 250W QT32 / E27	White, Titan, Colours	11429				+ Reflector Selection
791x250	1x max. 250W QT32 / E27 for ALUM. REFL. Ø440mm or REFL. PLACTIC PRISMATIC Ø406	Anodized	114299				+ Reflector Selection
792x26	2x26W TC-D / G24d-3	White, Titan, Colours			11432		+ Reflector Selection
792x26	2x26W TC-D / G24d-3 for ALUM. REFL. Ø360mm	Anodized			114329		+ Reflector Selection

	 140mm 228mm 360mm		 189mm 315mm	<ul style="list-style-type: none"> Smooth anodized aluminium reflector. or Prismatic reflector made of PMMA for direct/indirect light distribution. 	REFLECTORS CABANA 791x160 & 792x26  
PRICE LIST					
CODE	DESCRIPTION	COLOUR			
101101	SMOOTH REFL. Ø360mm	Aluminium			
807101	PRISMATIC REFL. Ø315	Plastic			

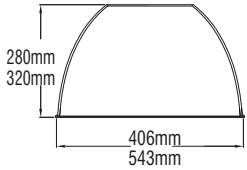

	 332mm Ø 440mm		 280mm 406mm	<ul style="list-style-type: none"> Smooth ribbed aluminium reflector. or Prismatic reflector made of PMMA for direct/indirect light distribution. 	REFLECTORS CABANA 791x250  
PRICE LIST					
CODE	DESCRIPTION	COLOUR			
101104	RIBBED REFL. Ø440mm	Aluminium			
807107	PRISMATIC REFL. Ø406	Plastic			

		SAVE 	 OSRAM: HQL PHILIPS: HPL	 OSRAM: NAV-E PHILIPS: SON	 OSRAM: HQI-E/NSI PHILIPS: HPI PLUS BU	YES (Body)
			 OSRAM: HWL PHILIPS: ML	<ul style="list-style-type: none"> • Steel body painted in white colour electrostatic (upon request in different colours). • The power supply enters through a PG 13,5 cable gland. • Designed for easy installation direct on the ceiling by a hook, or hanging with a chain or steel wire cable. 		



DESCRIPTION		COLOUR	Without Control Gear		Conventional ballast & capacitor		
			CODE	PRICE	CODE	PRICE	
For high pressure mercury vapour lamp							
YES 125	1x125W HME / E27	White			111032		+ Reflector Selection
YES 250	1x250W HME / E40	White			111042		+ Reflector Selection
YES 250 SAVE	1x250W HME / E40+1x100W QT32 / E27	White			115042		+ Reflector Selection
YES 400	1x400W HME / E40	White			111052		+ Reflector Selection
For high pressure sodium lamp							
YES 150	1x150W HSE / E40	White			111172		+ Reflector Selection
YES 251	1x250W HSE / E40	White			111182		+ Reflector Selection
YES 251 SAVE	1x250W HSE / E40+1x100W QT32 / E27	White			115182		+ Reflector Selection
YES 401	1x400W HSE / E40	White			111192		+ Reflector Selection
For metal halide lamp							
YES 150	1x150W HIE / E27	White			111082		+ Reflector Selection
YES 150	1x150W HIE / E40	White			111172		+ Reflector Selection
OSRAM HQI-E/NSI, PHILIPS HPI PLUS BU, SYLVANIA HSI-HX							
YES 250P	1x250W HIE / E40	White			111102		+ Reflector Selection
YES 400P SAVE	1x400W HIE / E40+1x100W QT32 / E27	White			115122		+ Reflector Selection
YES 400P	1x400W HIE / E40	White			111122		+ Reflector Selection
For self-ballasted lamp							
YES 160	1x160W QB / E27	White	111132				+ Reflector Selection
YES 253	1x max.500W QB / E40	White	111142				+ Reflector Selection



		<ul style="list-style-type: none"> • Prismatic reflector made of PMMA for direct/indirect light distribution. 	 	REFLECTOR YES PRISMATIC

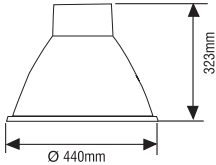

			PRICE LIST	
CODE	DESCRIPTION	COLOUR		
807107	PRISMATIC Ø406	Plastic		
807102	PRISMATIC Ø543	Plastic		



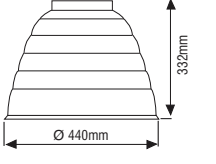

		Acrylic protective cover modulated to the reflector by a metal collar.	 	ACCESSORIES YES PRISMATIC

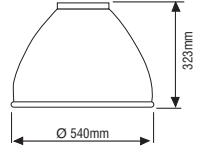





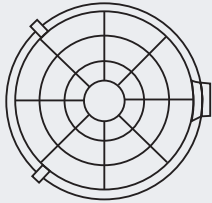



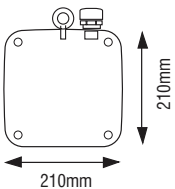









			PRICE LIST	
CODE	DESCRIPTION	COLOUR		
101405	PRISMATIC DIFFUSER for Ø406	Plastic		
101406	PRISMATIC DIFFUSER for Ø543	Plastic		







		<ul style="list-style-type: none"> • Specular reflector made of pure aluminium with smooth surface. Anodized in a highly specular finish. 	<p>REFLECTOR YES TECH</p> 
			PRICE LIST
CODE	DESCRIPTION	COLOUR	
101105	REFLECTOR TECH	Anodized	



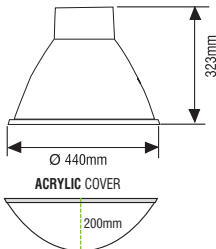



		<ul style="list-style-type: none"> • Specular reflector made of pure aluminium with ribbed surface. Anodized in a highly specular finish. 	<p>REFLECTOR YES RIG</p> 
			PRICE LIST
CODE	DESCRIPTION	COLOUR	
101104	REFLECTOR RIG	Anodized	

		<ul style="list-style-type: none"> • Specular reflector made of pure aluminium with smooth surface. Anodized in a highly specular finish. 	<p>REFLECTOR YES C</p> 
			PRICE LIST
CODE	DESCRIPTION	COLOUR	
101103	REFLECTOR C	Anodized	

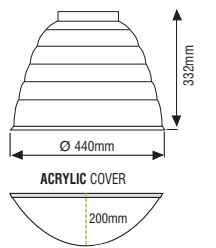
<p>TEMPERED GLASS</p> 	<p>ACRYLIC COVER</p> 	<p>GRILL</p> 	<p>ACCESSORIES YES TECH / RIG / C</p> <p>Tempered glass complete with stainless steel springs and silicon gasket. Recommended to use for metal halide lamps.</p> <p>Acrylic protection cover with stainless steel springs and silicon gasket. Recommended to use in food industry.</p> <p>Grill, zinc plated and steel coated in silver colour.</p> 
			PRICE LIST
CODE	DESCRIPTION	COLOUR	
101203	TEMPERED GLASS TECH / RIG		
101201	TEMPERED GLASS C		
101402	ACRYLIC COVER TECH / RIG		
101401	ACRYLIC COVER C		
101303	GRILL TECH / RIG		
101301	GRILL C		

		<table border="0"> <tr> <td></td> <td>OSRAM: HQL PHILIPS: HPL</td> <td></td> <td>OSRAM: NAV-E PHILIPS: SON</td> <td></td> <td>OSRAM: HQI-E/NSI PHILIPS: HPI PLUS BU</td> </tr> <tr> <td></td> <td>OSRAM: HWL PHILIPS: ML</td> <td></td> <td>OSRAM: HCI-T PHILIPS: CDM-T</td> <td colspan="2"></td> </tr> </table>		OSRAM: HQL PHILIPS: HPL		OSRAM: NAV-E PHILIPS: SON		OSRAM: HQI-E/NSI PHILIPS: HPI PLUS BU		OSRAM: HWL PHILIPS: ML		OSRAM: HCI-T PHILIPS: CDM-T			<p>YES SHOW (Body)</p>     
	OSRAM: HQL PHILIPS: HPL		OSRAM: NAV-E PHILIPS: SON		OSRAM: HQI-E/NSI PHILIPS: HPI PLUS BU										
	OSRAM: HWL PHILIPS: ML		OSRAM: HCI-T PHILIPS: CDM-T												
		PRICE LIST													
DESCRIPTION	COLOUR	Without Control Gear		Conventional ballast & capacitor		Electronic Control Gear									
		CODE	PRICE	CODE	PRICE										
For high pressure mercury vapour lamp															
YES SHOW 125 1x125W HME / E27	Titan			112032			+ Reflector Selection								
YES SHOW 250 1x250W HME / E40	Titan			112042			+ Reflector Selection								
YES SHOW 400 1x400W HME / E40	Titan			112052			+ Reflector Selection								
For high pressure sodium lamp															
YES SHOW 150 1x150W HSE / E40	Titan			112172			+ Reflector Selection								
YES SHOW 251 1x250W HSE / E40	Titan			112182			+ Reflector Selection								
YES SHOW 401 1x400W HSE / E40	Titan			112192			+ Reflector Selection								
For metal halide lamp															
YES SHOW 150 1x150W HIT-CE / G12	Titan			112222		112223	+ Reflector Selection								
YES SHOW 150 1x150W HIE / E27	Titan			112082			+ Reflector Selection								
YES SHOW 150 1x150W HIE / E40	Titan			112172			+ Reflector Selection								
OSRAM HQI-E/NSI, PHILIPS HPI PLUS BU, SYLVANIA HSI-HX															
YES SHOW 250P 1x250W HIE / E40	Titan			112102			+ Reflector Selection								
YES SHOW 400P 1x400W HIE / E40	Titan			112122			+ Reflector Selection								
For self-ballasted lamp															
YES SHOW 500 1x500W QB / E40	Titan	112149					+ Reflector Selection								

		<ul style="list-style-type: none"> Specular anodized reflector made of pure aluminium with smooth surface. Tempered glass fixed to the reflector with stainless steel springs and silicon gasket or Acrylic protection bowl fixed to the reflector with stainless steel springs and silicon gasket. <p>Recommended to use in food industry.</p>	<p>REFLECTOR YES SHOW TECH</p>     
		PRICE LIST	
CODE	DESCRIPTION	COLOUR	
101501	REFLECTOR + GLASS TECH	Anodized	
101502	REFLECTOR + ACRYLIC TECH	Anodized	

		<ul style="list-style-type: none"> Specular anodized reflector made of pure aluminium with ribbed surface. Tempered glass fixed to the reflector with stainless steel springs and silicon gasket or Acrylic protection bowl fixed to the reflector with stainless steel springs and silicon gasket. <p>Recommended to use in food industry.</p>	<p>REFLECTOR YES SHOW RIG</p>     
		PRICE LIST	
CODE	DESCRIPTION	COLOUR	
101505	REFLECTOR + GLASS RIG	Anodized	
101506	REFLECTOR + ACRYLIC RIG	Anodized	

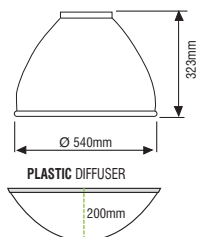

- Specular anodized reflector made of pure aluminium with smooth surface.
- Tempered glass fixed to the reflector with stainless steel springs and silicon gasket
or
- Acrylic protection bowl fixed to the reflector with stainless steel springs and silicon gasket.
Recommended to use in food industry.

**REFLECTOR
YES SHOW C**



PRICE LIST

CODE	DESCRIPTION	COLOUR
101503	REFLECTOR + GLASS C	Anodized
101504	REFLECTOR + ACRYLIC C	Anodized

