

**TC-D** OSRAM: DULUX D  
PHILIPS: PL-C

**TC-DEL** OSRAM: DULUX D/E  
PHILIPS: PL-C/4P

**TC-TEL** OSRAM: DULUX T / E  
PHILIPS: PL-T / 4P

- Dodecagonal high efficiency louvre made up with segments in specular aluminium.
- Ring in polycarbonate.

**3F DODECA 220 2MG**  
HIGH REFLECTOR  
(DOWNLIGHTS)

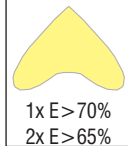

1x E > 70%  
2x E > 65%



DESCRIPTION		COLOUR	PRICE LIST			
			Conventional ballast and capacitor		Electronic ballast	
			CODE	PRICE	CODE	PRICE
1x18W	TC-D / G24d-2 or TC-DEL / G24q-2	White	401221		401231	
1x26W	TC-D / G24d-3 or TC-DEL / G24q-3	White	401321		401331	
1x32W	TC-TEL / G24q-3	White			401431	
1x42W	TC-TEL / G24q-4	White			401531	
2x18W	TC-D / G24d-2 or TC-DEL / G24q-2	White	401721		401731	
2x26W	TC-D / G24d-3 or TC-DEL / G24q-3	White	401821		401831	
1x18W	TC-D / G24d-2 or TC-DEL / G24q-2	Titan	401222		401232	
1x26W	TC-D / G24d-3 or TC-DEL / G24q-3	Titan	401322		401332	
1x32W	TC-TEL / G24q-3	Titan			401432	
1x42W	TC-TEL / G24q-4	Titan			401532	
2x18W	TC-D / G24d-2 or TC-DEL / G24q-2	Titan	401722		401732	
2x26W	TC-D / G24d-3 or TC-DEL / G24q-3	Titan	401822		401832	

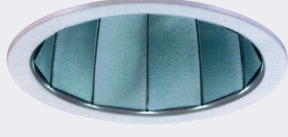

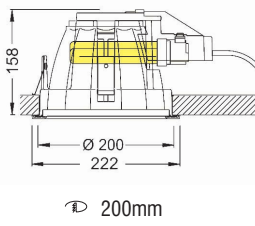

**TC-D** OSRAM: DULUX D  
PHILIPS: PL-C

**TC-DEL** OSRAM: DULUX D/E  
PHILIPS: PL-C/4P

**TC-TEL** OSRAM: DULUX T / E  
PHILIPS: PL-T / 4P

- Dodecagonal non-reflecting louvre made up with segments in semi-specular aluminium.
- Ring in polycarbonate.

**3F DODECA 220 2S**  
HIGH REFLECTOR  
(DOWNLIGHTS)

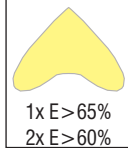

1x E > 65%  
2x E > 60%



DESCRIPTION		COLOUR	PRICE LIST			
			Conventional ballast and capacitor		Electronic ballast	
			CODE	PRICE	CODE	PRICE
1x18W	TC-D / G24d-2 or TC-DEL / G24q-2	White	402221		402231	
1x26W	TC-D / G24d-3 or TC-DEL / G24q-3	White	402321		402331	
1x32W	TC-TEL / G24q-3	White			402431	
1x42W	TC-TEL / G24q-4	White			402531	
2x18W	TC-D / G24d-2 or TC-DEL / G24q-2	White	402721		402731	
2x26W	TC-D / G24d-3 or TC-DEL / G24q-3	White	402821		402831	
1x18W	TC-D / G24d-2 or TC-DEL / G24q-2	Titan	402222		402232	
1x26W	TC-D / G24d-3 or TC-DEL / G24q-3	Titan	402322		402332	
1x32W	TC-TEL / G24q-3	Titan			402432	
1x42W	TC-TEL / G24q-4	Titan			402532	
2x18W	TC-D / G24d-2 or TC-DEL / G24q-2	Titan	402722		402732	
2x26W	TC-D / G24d-3 or TC-DEL / G24q-3	Titan	402822		402832	

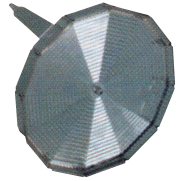

**3F DODECA 220 2MG & 2S**  
**- ACCESSORIES**  
DIFFUSER  
(DOWNLIGHTS)

Closing **diffuser** in prismatic self-extinguishing V2 polycarbonate, **IP44** exposed part, for luminaires 3F Dodeca 220 2MG & 2S 1-2x18W and 1x26W.

**6,5J**

DESCRIPTION			PRICE LIST	
CODE	DESCRIPTION	COLOUR		
400101	DIFFUSER 0194			



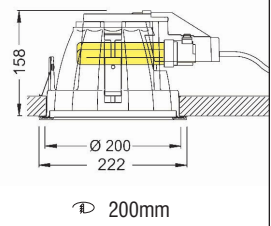





**TC-D** OSRAM: DULUX D  
PHILIPS: PL-C

**TC-DEL** OSRAM: DULUX D/E  
PHILIPS: PL-C/4P

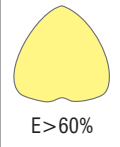
**TC-TEL** OSRAM: DULUX T / E  
PHILIPS: PL-T / 4P

**3F DODECA 220 2MG VS**  
HIGH REFLECTOR  
(DOWNLIGHTS)





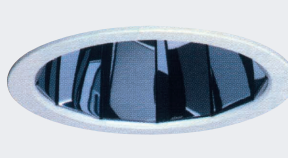

- Dodecagonal high efficiency louvre made up with segments in specular aluminium.
- Decorative tempered moulded glass, locked and in line with the ring.

DESCRIPTION		COLOUR	PRICE LIST			
			Conventional ballast and capacitor		Electronic ballast	
			CODE	PRICE	CODE	PRICE
1x18W	TC-D / G24d-2 or TC-DEL / G24q-2	White	403221		403231	
1x26W	TC-D / G24d-3 or TC-DEL / G24q-3	White	403321		403331	
1x32W	TC-TEL / G24q-3	White			403431	
1x42W	TC-TEL / G24q-4	White			403531	
2x18W	TC-D / G24d-2 or TC-DEL / G24q-2	White	403721		403731	
2x26W	TC-D / G24d-3 or TC-DEL / G24q-3	White	403821		403831	
1x18W	TC-D / G24d-2 or TC-DEL / G24q-2	Titan	403222		403232	
1x26W	TC-D / G24d-3 or TC-DEL / G24q-3	Titan	403322		403332	
1x32W	TC-TEL / G24q-3	Titan			403432	
1x42W	TC-TEL / G24q-4	Titan			403532	
2x18W	TC-D / G24d-2 or TC-DEL / G24q-2	Titan	403722		403732	
2x26W	TC-D / G24d-3 or TC-DEL / G24q-3	Titan	403822		403832	

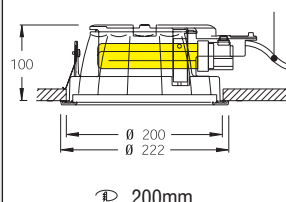





∅ 200mm

TC-D OSRAM: DULUX D  
PHILIPS: PL-C

TC-DEL OSRAM: DULUX D/E  
PHILIPS: PL-C/4P

**3F DODECA 220 AC 2MG**  
HIGH REFLECTOR  
(DOWNLIGHTS)

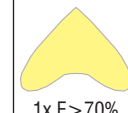

1x E > 70%  
2x E > 65%



- Dodecagonal high efficiency louvre made up with segments in specular aluminium.
- Ring in polycarbonate

DESCRIPTION		COLOUR	PRICE LIST			
			Conventional ballast and capacitor		Electronic ballast	
			CODE	PRICE	CODE	PRICE
1x18W	TC-D / G24d-2 or TC-DEL / G24q-2	White	404221		404231	
1x26W	TC-D / G24d-3 or TC-DEL / G24q-3	White	404321		404331	
2x18W	TC-D / G24d-2 or TC-DEL / G24q-2	White	404721		404731	
2x26W	TC-D / G24d-3 or TC-DEL / G24q-3	White	404821		404831	
1x18W	TC-D / G24d-2 or TC-DEL / G24q-2	Titan	404222		404232	
1x26W	TC-D / G24d-3 or TC-DEL / G24q-3	Titan	404322		404332	
2x18W	TC-D / G24d-2 or TC-DEL / G24q-2	Titan	404722		404732	
2x26W	TC-D / G24d-3 or TC-DEL / G24q-3	Titan	404822		404832	



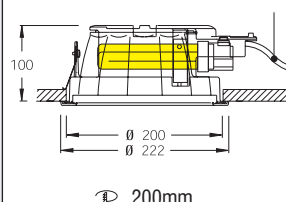

∅ 200mm

TC-D OSRAM: DULUX D  
PHILIPS: PL-C

TC-DEL OSRAM: DULUX D/E  
PHILIPS: PL-C/4P

**3F DODECA 220 AC 2MG VS**  
HIGH REFLECTOR  
(DOWNLIGHTS)



1x E > 48%  
2x E > 40%

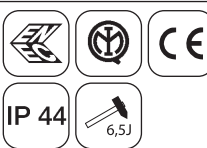

- Dodecagonal high efficiency louvre made up with segments in specular aluminium.
- Decorative tempered moulded glass, locked and in line with the ring.

DESCRIPTION		COLOUR	PRICE LIST			
			Conventional ballast and capacitor		Electronic ballast	
			CODE	PRICE	CODE	PRICE
1x18W	TC-D / G24d-2 or TC-DEL / G24q-2	White	405221		405231	
1x26W	TC-D / G24d-3 or TC-DEL / G24q-3	White	405321		405331	
2x18W	TC-D / G24d-2 or TC-DEL / G24q-2	White	405721		405731	
2x26W	TC-D / G24d-3 or TC-DEL / G24q-3	White	405821		405831	
1x18W	TC-D / G24d-2 or TC-DEL / G24q-2	Titan	405222		405232	
1x26W	TC-D / G24d-3 or TC-DEL / G24q-3	Titan	405322		405332	
2x18W	TC-D / G24d-2 or TC-DEL / G24q-2	Titan	405722		405732	
2x26W	TC-D / G24d-3 or TC-DEL / G24q-3	Titan	405822		405832	



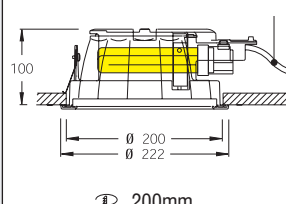

∅ 200mm

TC-D OSRAM: DULUX D  
PHILIPS: PL-C

TC-DEL OSRAM: DULUX D/E  
PHILIPS: PL-C/4P

**3F DODECA 220 AC 2MG VDT**  
HIGH REFLECTOR  
(DOWNLIGHTS)



1x E > 58%  
2x E > 51%



Decorative tempered moulded glass, locked and in line with the ring high efficiency reflector in specular aluminium. Cruciform louvre non-iridescent made of pure aluminium.

DESCRIPTION		COLOUR	PRICE LIST			
			Conventional ballast and capacitor		Electronic ballast	
			CODE	PRICE	CODE	PRICE
1x18W	TC-D / G24d-2 or TC-DEL / G24q-2	White	406221		406231	
1x26W	TC-D / G24d-3 or TC-DEL / G24q-3	White	406321		406331	
2x18W	TC-D / G24d-2 or TC-DEL / G24q-2	White	406721		406731	
2x26W	TC-D / G24d-3 or TC-DEL / G24q-3	White	406821		406831	
1x18W	TC-D / G24d-2 or TC-DEL / G24q-2	Titan	406222		406232	
1x26W	TC-D / G24d-3 or TC-DEL / G24q-3	Titan	406322		406332	
2x18W	TC-D / G24d-2 or TC-DEL / G24q-2	Titan	406722		406732	
2x26W	TC-D / G24d-3 or TC-DEL / G24q-3	Titan	406822		406832	

**TC-D** OSRAM: DULUX D  
PHILIPS: PL-C

**TC-DEL** OSRAM: DULUX D/E  
PHILIPS: PL-C/4P

**TC-TEL** OSRAM: DULUX T / E  
PHILIPS: PL-T / 4P

- Dodecagonal high efficiency louvre made up with segments in specular aluminium.
- Ring in polycarbonate.

**3F DODECA 300 2MG**  
(DOWNLIGHTS)

		<b>PRICE LIST</b>			
DESCRIPTION	COLOUR	Conventional ballast and capacitor		Electronic ballast	
		CODE	PRICE	CODE	PRICE
1x26W TC-D / G24d-3 or TC-DEL / G24q-3	White	407121		407131	
1x32W TC-TEL / GX24q-3	White			407231	
1x42W TC-TEL / GX24q-4	White			407331	
2x26W TC-D / G24d-3 or TC-DEL / G24q-3	White	407421		407431	
2x32W TC-TEL / GX24q-3	White			407531	
2x42W TC-TEL / GX24q-4	White			407631	
1x26W TC-D / G24d-3 or TC-DEL / G24q-3	Titan	407122		407132	
1x32W TC-TEL / GX24q-3	Titan			407232	
1x42W TC-TEL / GX24q-4	Titan			407332	
2x26W TC-D / G24d-3 or TC-DEL / G24q-3	Titan	407422		407432	
2x32W TC-TEL / GX24q-3	Titan			407532	
2x42W TC-TEL / GX24q-4	Titan			407632	

**TC-D** OSRAM: DULUX D  
PHILIPS: PL-C

**TC-DEL** OSRAM: DULUX D/E  
PHILIPS: PL-C/4P

**TC-TEL** OSRAM: DULUX T / E  
PHILIPS: PL-T / 4P

- Dodecagonal non-reflecting louvre made up with segments in semi-specular aluminium.
- Ring in polycarbonate.

**3F DODECA 300 2S**  
(DOWNLIGHTS)

		<b>PRICE LIST</b>			
DESCRIPTION	COLOUR	Conventional ballast and capacitor		Electronic ballast	
		CODE	PRICE	CODE	PRICE
1x26W TC-D / G24d-3 or TC-DEL / G24q-3	White	408121		408131	
1x32W TC-TEL / GX24q-3	White			408231	
1x42W TC-TEL / GX24q-4	White			408331	
2x26W TC-D / G24d-3 or TC-DEL / G24q-3	White	408421		408431	
2x32W TC-TEL / GX24q-3	White			408531	
2x42W TC-TEL / GX24q-4	White			408631	
1x26W TC-D / G24d-3 or TC-DEL / G24q-3	Titan	408122		408132	
1x32W TC-TEL / GX24q-3	Titan			408232	
1x42W TC-TEL / GX24q-4	Titan			408332	
2x26W TC-D / G24d-3 or TC-DEL / G24q-3	Titan	408422		408432	
2x32W TC-TEL / GX24q-3	Titan			408532	
2x42W TC-TEL / GX24q-4	Titan			408632	

**TC-TEL** OSRAM: DULUX T / E  
PHILIPS: PL-T / 4P

- Dodecagonal high efficiency louvre made up with segments in specular aluminium.
- Decorative tempered moulded glass, locked and in line with the ring.

**3F DODECA 300 2MG VS**  
(DOWNLIGHTS)

		<b>PRICE LIST</b>			
DESCRIPTION	COLOUR	Conventional ballast and capacitor		Electronic ballast	
		CODE	PRICE	CODE	PRICE
1x32W TC-TEL / GX24q-3	White			409231	
1x42W TC-TEL / GX24q-4	White			409331	
1x32W TC-TEL / GX24q-3	Titan			409232	
1x42W TC-TEL / GX24q-4	Titan			409332	



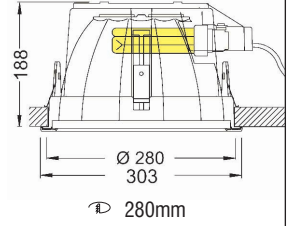



188  
Ø 280  
303  
280mm

**TC-TEL** OSRAM: DULUX T / E  
PHILIPS: PL-T / 4P

Decorative tempered moulded glass, locked and in line with the ring high efficiency reflector in specular aluminium. Cruciform louvre non-iridescent made of pure aluminium.

**3F DODECA 300 2MG SK**  
(DOWNLIGHTS)

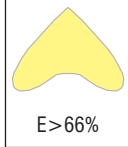
E > 66%

DESCRIPTION		COLOUR		PRICE LIST			
				Conventional ballast and capacitor		Electronic ballast	
				CODE	PRICE	CODE	PRICE
2x32W	TC-TEL / GX24q-3	White				410531	
2x42W	TC-TEL / GX24q-4	White				410631	
2x32W	TC-TEL / GX24q-3	Titan				410532	
2x42W	TC-TEL / GX24q-4	Titan				410632	



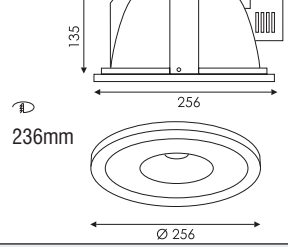

135  
256  
236mm  
Ø 256



**TC-D** OSRAM: DULUX D  
PHILIPS: PL-C

**TC-DEL** OSRAM: DULUX D/E  
PHILIPS: PL-C/4P

**TC-TEL** OSRAM: DULUX T / E  
PHILIPS: PL-T / 4P

- Semi-specular anodized aluminium reflector with a fine pearl structure trim with opal polycarbonate cover and centered reflector.
- Aluminium ring (flange).

**EPT+Z-KEPT**  
(DOWNLIGHTS)

DESCRIPTION		COLOUR		PRICE LIST			
				Conventional ballast and capacitor		Electronic ballast	
				CODE	PRICE	CODE	PRICE
2x26W	TC-D / G24d-3 or TC-DEL / G24q-3	White		484121		484131	
2x32-42W	TC-TEL / GX24q-3	White				484231	
2x26W	TC-D / G24d-3 or TC-DEL / G24q-3	Titan		484122		484132	
2x32-42W	TC-TEL / GX24q-3	Titan				484232	



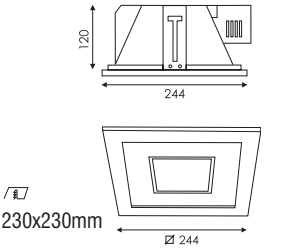

120  
244  
230x230mm  
Ø 244



**TC-D** OSRAM: DULUX D  
PHILIPS: PL-C

**TC-DEL** OSRAM: DULUX D/E  
PHILIPS: PL-C/4P

**TC-TEL** OSRAM: DULUX T / E  
PHILIPS: PL-T / 4P

- Semi-specular anodized aluminium reflector with a fine pearl structure trim with opal polycarbonate cover and centered reflector.
- Aluminium ring (flange).

**EPQN+Z-KEPQN**  
(DOWNLIGHTS)

DESCRIPTION		COLOUR		PRICE LIST			
				Conventional ballast and capacitor		Electronic ballast	
				CODE	PRICE	CODE	PRICE
2x26W	TC-D / G24d-3 or TC-DEL / G24q-3	White		483121		483131	
2x32-42W	TC-TEL / GX24q-3	White				483231	
2x26W	TC-D / G24d-3 or TC-DEL / G24q-3	Titan		483122		483132	
2x32-42W	TC-TEL / GX24q-3	Titan				483232	