

YES SHOW



Technical Features

- Luminaires for mercury vapor lamps (HME), metal halide lamps (HIE, HIT-CE), high pressure sodium lamps (HSE), self-ballasted lamps.
- Steel body, painted electrostatically in silver colour. The perimeter has wide cooling fins for dissipation of the heat that is developed in the control gear area.
- Reflector from specular anodised aluminum (smooth: **TECH, C** or ribbed: **RIG**).
- Tempered protection glass, with seal rubber, adjusted to the reflector with steel clips **or** Acrylic protection cover, with seal rubber, adjusted to the reflector with steel clips.
Recommended for use in food industries.
- Lampholder E27, E40, G12 made of porcelain.
- Input of the power cable through cable gland type PG 13,5.
- Mounted to the ceiling with a hook. Suspended with chain or cord.
- Connection for operation on 230V-50Hz with conventional control gear and power factor correction capacitor.
- Connection for operation with electronic control gear (lamp HIT-CE).

YES SHOW

YES - Body

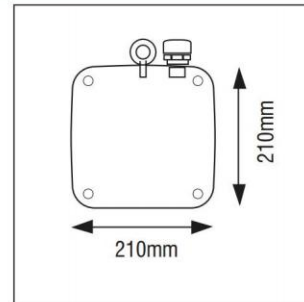
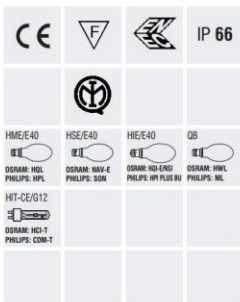

Description	Without Control Gear Code	Conventional Ballast and capacitor Code	Electronic Ballast Code
For high pressure mercury vapour lamp			
YES SHOW 125	1x125W HME / E27	112032	
YES SHOW 250	1x250W HME / E40	112042	
YES SHOW 400	1x400W HME / E40	112052	
For high pressure sodium lamp			
YES SHOW 150	1x150W HSE / E40	112172	
YES SHOW 251	1x250W HSE / E40	112182	
YES SHOW 401	1x400W HSE / E40	112192	
For metal halide lamp			
YES SHOW 150	1x150W HIT-CE / G12	112222	112223
YES SHOW 150	1x150W HIE / E27	112082	
YES SHOW 150	1x150W HIE / E40	112172	
OSRAM HQI-E/NSI, PHILIPS HPI PLUS BU, SYLVANIA HSI-HX			
YES SHOW 250P	1x250W HIE / E40	112102	
YES SHOW 400P	1x400W HIE / E40	112122	
For self-ballasted lamp			
YES SHOW 500	1x500W QB / E40	112149	



YES SHOW - REFLECTORS

YES SHOW TECH

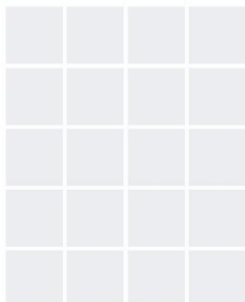

Code	Description
101501	REFLECTOR + GLASS TECH
101502	REFLECTOR + ACRYLIC COVER TECH

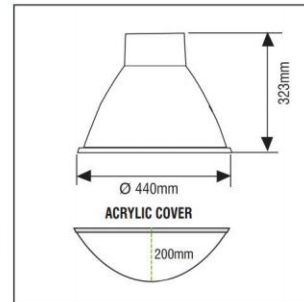

YES SHOW RIG

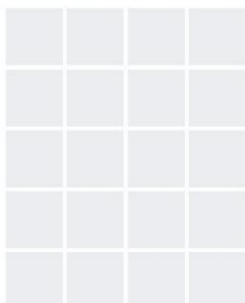

Code	Description
101505	REFLECTOR + GLASS RIG
101506	REFLECTOR + ACRYLIC COVER RIG

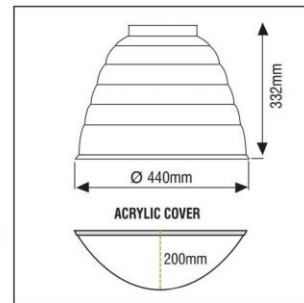

YES SHOW C

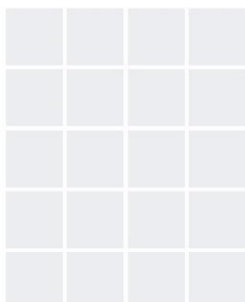

Code	Description
101503	REFLECTOR + GLASS C
101504	REFLECTOR + ACRYLIC COVER C

